

**BE-S905X**

- rev.0- Drawing issued on 25/05/2021

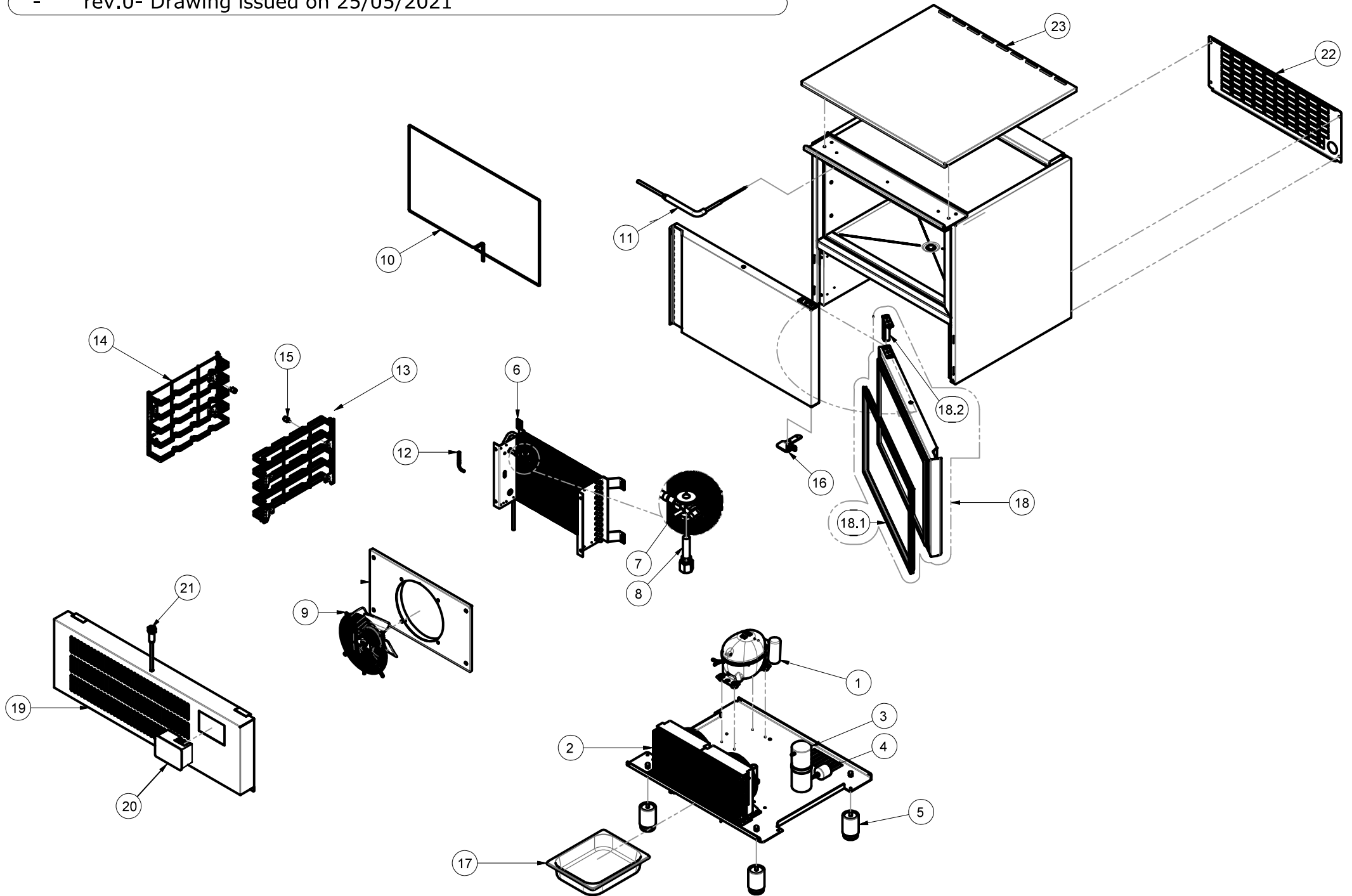

(IT)

(EN)

(FR)

(D)

pos.	qty	descrizione	description	description	Beschreibung	cod.
1	1	Compressore	Compressor	Compresseur	Kompressor	4311110
2	1	Condensatore	Condenser	Condenseur	Verflüssiger	4320120
3	1	Ricevitore di liquido	Liquid receiver	Récepteur de liquide	Flüssigkeitsbehälter	4360010
4	1	Filtro deidratatore	Drier filter	Filtre déshydrateur	Filtertrockner	4350010
5	4	Piedino regolabile	Adjustable foot	Pied réglable	Verstellbarer Fuß	3360080
6	1	Evaporatore	Evaporator	Évaporateur	Verdampfer	4330110
7	1	Valvola termostatica	Thermostatic valve	Vanne thermostatique	Thermostatventil	4340320
8	1	Orifizio	Orifice	Orifice	Öffnung	4340110
9	1	Ventilatore	Fan	Ventilateur	Fan	7750070
10	1	Resistenza cornice	Heating element for frame	Élément chauffant cadre	Heizelement für Rahmen	4661110
11	1	Sonda a cuore	Core probe	Sonde de température	Temperaturfühler	4630610
12	1	Sonda temperatura cella	Cell temperature probe	Sonde température cellulaire	Zelltemperaturfühler	4630510
13	1	Spalliera reggigriglie	Grid stead	Grille place	Gitter statt	7320650
14	1	Spalliera reggigriglie	Grid stead	Grille place	Gitter statt	7320640
15	8	Perno Spalliera reggigriglie	Pin for grid stead	Goupille pour grille	Stift für Gitterstützstruktur	3210180
16	1	Assieme Cerniera inferiore	Lower hinge	Charnière inférieure	Unteres Reißverschluss	7261150
17	1	Bacinella PP	Plastic bowl	Bol en plastique	Plastikschüssel	3630060
18	1	Assieme porta schiumata	Foamed door	Porte isolée	geschäumte Tür	7431330
18.1	1	Guarnizione porta	Gasket for foamed door	Joint de porte	Türdichtung	3510240
18.2	1	Assieme Cerniera superiore	Upper hinge	Charnière supérieure	Oberer Reißverschluss	3330100
19	1	Assieme cruscotto	Assembled dashboard	Tableau de bord ensemble	Armaturenbrett zusammen	7723480
20	1	Scheda EVJ815P9PX3	Electronic card EVJ815P9PX3	Carte électronique EVJ815P9PX3	Registerkarte EVJ815P9PX3	4622340
21	1	Microporta magnetico	Magnetic microswitch	Micro-interrupteur	Mikroschalter	4611011
22	1	Copertura posteriore	Rear cover	Couverture arrière	Rückseite	6320340
23	1	Piano	Upper surface	Surface plane	Oberfläche	7212030