

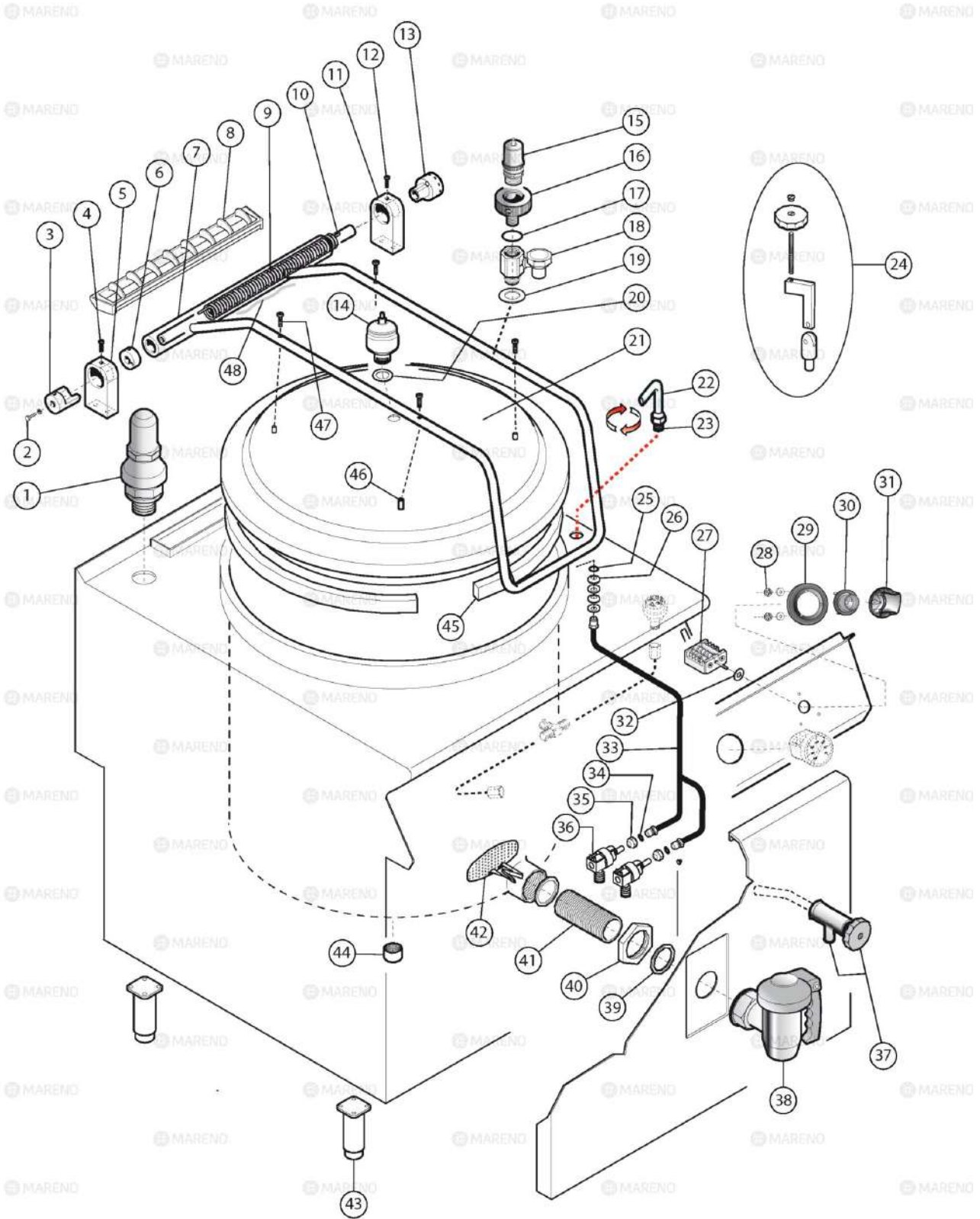

 MARENO ALI spa Mareno di Piave (TV)	COTTURA STAR 90		NPD98E15	
	PENTOLE ELETTRICHE DIRETTE			
	3_ST90_089_8_00		0916	Pag. 1.1

Pos	Code	Description
0002	LA65080250	ENERGY REGULATOR [C]
0003	CR0588310	CRUSCOTTO PENTOLE DIRETTE 900
0004	CR1094330	KNOB [C] SHAFT D. 6
0005	CR0935250	BUSH [C]
0006	CR0589870	METAL LABEL [C]
0007	CR0587500	ORANGE PILOT LAMP [C]
0008	MA1878500	THERMOSTAT [C] 360Â°C
0009	MACM187301	CONTACTOR [C]
0010	MA1984000	ELECTRIC NOISE FILTER [C]
0011	MA1037112400	FAIRLEAD [C]
0012	MA1037114500	LOCK NUT [C]
0013	MA1878400	TERMINAL BLOCK [C]
0014	CR0682150	HEATING ELEMENT [C] PAN 900
0016	CR0683790	BULB HOLDER DIRECT POT



 MARENO ALI spa Mareno di Piave (TV)	COTTURA STAR 90	NP98
	PENTOLE PARTICOLARI COMUNI	
	3_ST90_081_8_00	0916

Pos	Code	Description
0002	MA1033509200	SCREW [C] M8X25 UNI EN ISO 4017
0003	CR0586320	HINGE SUPPORT BUSH [C]
0004	CR0589090	SCREW [C]
0005	CR0586370	SUPPORT [C] HINGE
0006	CR0586310	HINGE BUSH [C] FOR PAN
0007	CR0586500	HANDLE [C] PAN 900
0008	CR0580380	PROTECTION GRID [C] SMOKE DRAIN M60
0009	CR0586350	SPRING [C] HINGE
0010	CR0586360	PIN [C] HINGE CONNECTION
0011	CR0586370	SUPPORT [C] HINGE
0012	CR0589090	SCREW [C]
0013	CR0586330	HINGE SUPPORT BUSH [C]
0021	CR0586560	COVER [C] PAN
0022	MA450000	TAP [C] PANS
0023	CR1090060	ADAPTER [C]
0025	CR0682650	GASKET [C]
0026	CR0682570	SPRING [C] UNI 8737-B 40 GR2-50Cr V4
0027	CR0581810	4 WAYS COMMUTATOR [C]
0028	CR0588950	EXTENSION [C] DRAIN PASTA COOKER 900
0029	CR0682580	METAL LABEL [C]
0030	CR0935250	BUSH [C]
0031	CR1094330	KNOB [C] SHAFT D. 6
0033	CR0587460	PIPE [C] PAN TAP
0034	MA2867700	GASKET [C] 9,19X2,62
0035	CR0682340	NUT [C]
0036	CR1220380R	SOLENOID VALVE [C] WATER
0038	CR0682781	DRAIN TAP [C]
0039	MA1420925	GASKET [C] TAP
0040	MA14044899	LOCK NUT [C]
0041	CR1079243	NIPPLO 2
0042	MA111700	PROTECTION GRID [C] PAN DRAIN
0043	MA6086113	FOOT ASSEMBLY [C] H. 200
0044	MA14047599	TAPPO FEMMINA 3/4" FIG.300 GHISA / ZN
0045	CR0687120	GASKET [C] AUTOCLAVE PAN
0046	CR0586460	SPACER [C] HANDLE
0047	CR0587940	SCREW [C]
0048	CR1078870	SINT GREASE MP 260/0 KG.5



 MARENO ALI spa Mareno di Piave (TV)	COTTURA STAR 90		NP98	
	PENTOLE PARTICOLARI COMUNI			
	3_ST90_082_8_00		0916	Pag. 1.1

Pos	Code	Description
0001	MA77122700	PIN [C] HANDLE CLAMPING
0002	MA77122600	HEATLESS HANDLE [C]
0003	MA1420925	GASKET [C] TAP
0004	MA77122400	GREASE [C]