

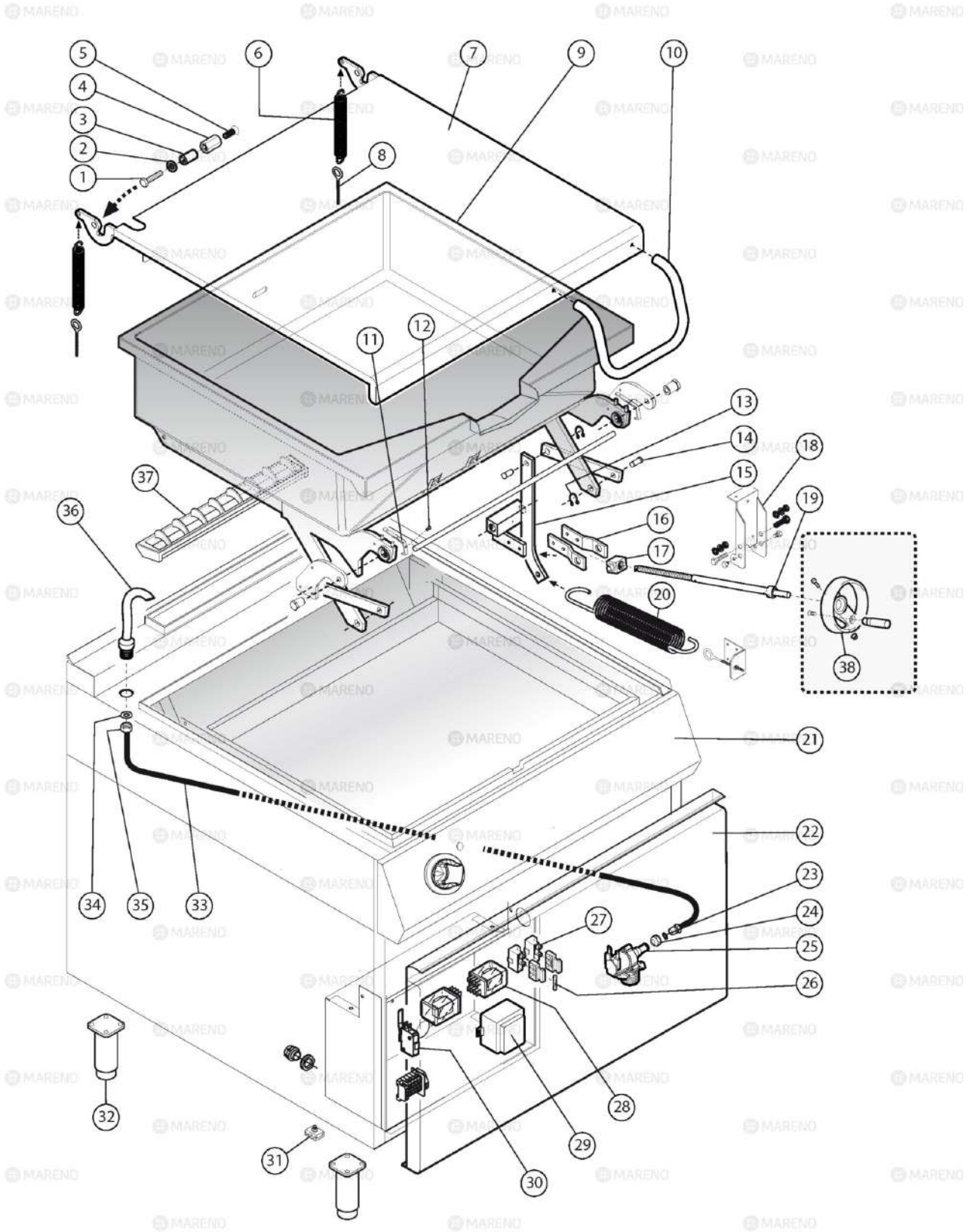

 MARENO ALI spa Mareno di Piave (TV)	COTTURA STAR 90		NBR98E	
	BRASIERA ELETTRICA			
	3_ST90_054_8_00		0916	Pag. 1.1

Pos	Code	Description
0001	CR0939930	EXTENSION M5X75
0002	CR0939940	HEATING ELEMENT [C] 1500W 400V BRATT PAN 900 M80
0003	CR0686831	BULB HOLDER ELECTRIC BRATT PAN
0004	CR0939850	PROTECTION [C] HEATING ELEMENTS BRATT PANS 900 M80
0005	MA1878500	THERMOSTAT [C] 360Â°C
0007	CR0587500	ORANGE PILOT LAMP [C]
0008	CR1094330	KNOB [C] SHAFT D. 6
0009	CR0935250	BUSH [C]
0010	CR0685100	METAL LABEL [C]
0011	CR0588950	EXTENSION [C] DRAIN PASTA COOKER 900
0012	MACM187401	CONTACTOR [C]
0013	CR0506300	ELECTRIC NOISE FILTER [C]
0014	MA1878400	TERMINAL BLOCK [C]
0015	MA1037114500	LOCK NUT [C]
0016	MA1037112400	FAIRLEAD [C]
0017	MACM199801	FLEXIBLE PIPE [C]
0018	CR0581280	THERMOSTAT [C]
0019	CR0970060	CABLE SET [C] ELECTRIC MOTOR BRATT PAN 90 M80
0020	CR0939870	HEATER BOX [C]



ID GAS: □ G30/50 ◆ G30/37 ■ G30/29 ○ G20/20 ✦ G20/25 ● G25/25 ◊ G25.1/25 ★ G25/20 ✧ G120/8 ⊙ G110/8

 MARENO ALI spa Mareno di Piave (TV)	COTTURA STAR 90	NBR9_8_12 G/E
	BRASIERA A GAS E ELETTRICHE PARTICOLARI COMUNI	
	3_ST90_051_8_12_00	0916

Pos	Code	Description
0001	CR0682730	SCREW [C] M8X20 UNI EN ISO 24017
0002	MA15830699	WASHER [C]
0003	CR0681090	COVER BUSH [C] FOR BRATT PAN
0004	CR0681371	NUT [C]
0005	CR0686220	SCREW [C] M5X8 UNI EN ISO 7046
0006	CR0589520	SPRING [C] COVER BALANCING
0007	CR0681270	COVER [C] BRATT PAN 900 M80
0008	CR0589730	SCREW COUPLING [C]
0009	CR0589772	TANK [C]
0010	CR0682470	HANDLE [C] BRATT PAN 900
0011	CR0681760	SUPPORT [C] CONTROL PANEL BRATT PAN
0012	MA15640499	SCREW [C] M5X8
0013	CR0589720	GASKET [C]
0014	CR0589710	PIN [C] CONNECTING ROD
0015	CR0589360	LIFTING DEVICE [C] TANK BRATT PAN
0016	CR0589560	SUPPORT [C] FEMALE SCREW BRATT PAN
0017	MACM184300	NUT SCREW [C]
0018	CR0682191	SUPPORT [C] SCREW ACTUATOR BRATT PAN 900
0019	CR0589590	SCREW [C] BRATT PAN 900
0020	CR0589690	SPRING [C] TANK BALANCING BRATT PAN
0021	CR0732950	FRONT PANEL ASSEMBLY [C] ELECTRIC BRATT PAN 700
0022	CR0682511	FRONT PANEL [C] M80 900
0023	MA2867700	GASKET [C] 9,19X2,62
0024	CR0682340	NUT [C]
0025	CR1220380R	SOLENOID VALVE [C] WATER
0026	CR0687731	FUSE [C] 250V 5A
0027	CR1226350	FUSE CARRIER [C]
0028	CR0687240	RELAY [C]
0029	CR0684780	TRANSFORMER [C] 230/24V
0030	MA1037111300	MICROSWITCH [C]
0031	MA1878400	TERMINAL BLOCK [C]
0032	MA6086113	FOOT ASSEMBLY [C] H. 200
0033	CR0682430	PIPE [C] BRATT PAN 900 TAP
0034	MA14072299	GASKET [C] FLEX 1/2
0035	MACM066200	NUT 1/2
0036	CR0681381	TAP [C] BRATT PAN
0037	CR0580380	PROTECTION GRID [C] SMOKE DRAIN M60
0038	MA1475201	HANDWHEEL [C]

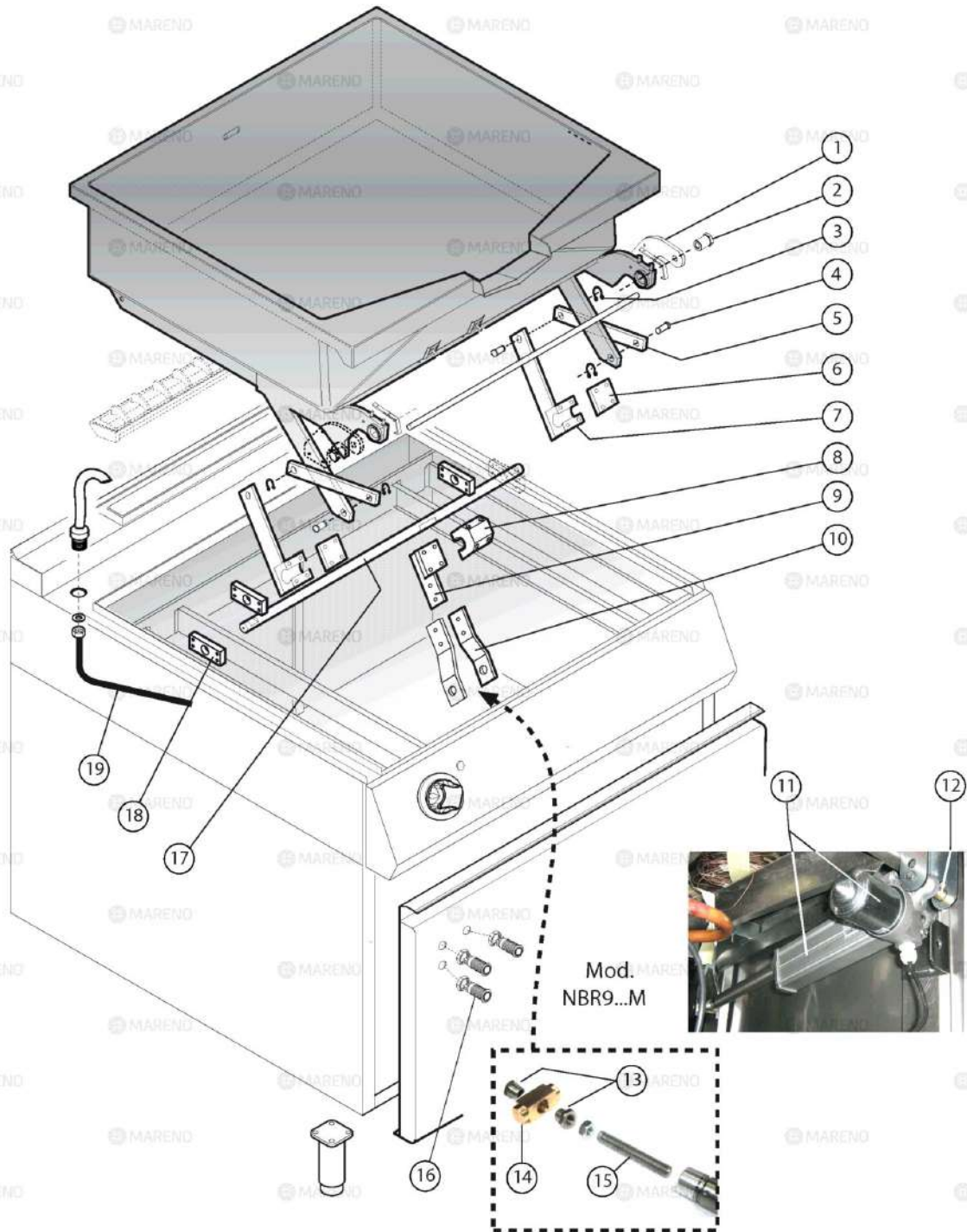

ID GAS: □ G30/50 ◆ G30/37 ■ G30/29 ○ G20/20 ✦ G20/25 ● G25/25 ◊ G25.1/25 ★ G25/20 ✧ G120/8 ⊙ G110/8

 MARENO ALI spa Mareno di Piave (TV)	COTTURA STAR 90	NBR9_8_12 G/E
	BRASIERA A GAS E ELETTRICHE PARTICOLARI COMUNI	
	3_ST90_052_8_12_00	0916

Pos	Code	Description
0001	CR0589782	SUPPORT [C] TANK BRATT PAN M120
0002	CR0589840	PIVOTING PIN [C] BRAT TANK
0003	CR0589720	GASKET [C]
0004	CR0589710	PIN [C] CONNECTING ROD
0005	CR0589510	CONNECTING ROD [C]
0006	CR0840620	PLATE [C]
0008	CR0841370	SUPPORT LIFTING SYSTEM [C] M120
0009	CR0840641	LIFTING SYSTEM [C] CENTER TANK BRATT PAN M120
0010	CR0589560	SUPPORT [C] FEMALE SCREW BRATT PAN
0011	CR0684360	ACTUATOR [C]
0012	CR0684320	SPACER [C] ACTUATOR
0013	CR0684310	RING NUT [C]
0014	CR0684300	HINGE [C] FRONT ACTUATOR FOR BRATT PAN
0015	CR0686360	CONNECTION [C]
0016	CR0937810	BUTTON [C]
0017	CR0939840	LIFTING SYSTEM [C] BRATT PAN TANK M80 (KB)
0018	CR0797490	SUPPORT [C] BUSH BRATT PAN M120
0019	CR0840600	PIPE [C] BRATT PAN M80-120