



Assembly code	Assembly description	Assembly image
ASM2300A/0.D07	General overview	
ASM2320A/0.D07	General overview	
ASM2330A/0.D00	General overview	

ASM2300A/0.D07 - General overview - FRONT



ASM2300A/0.D07 - General overview - REAR

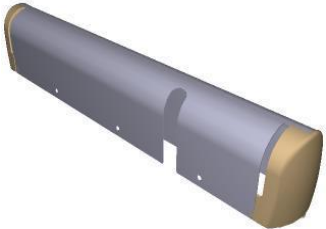
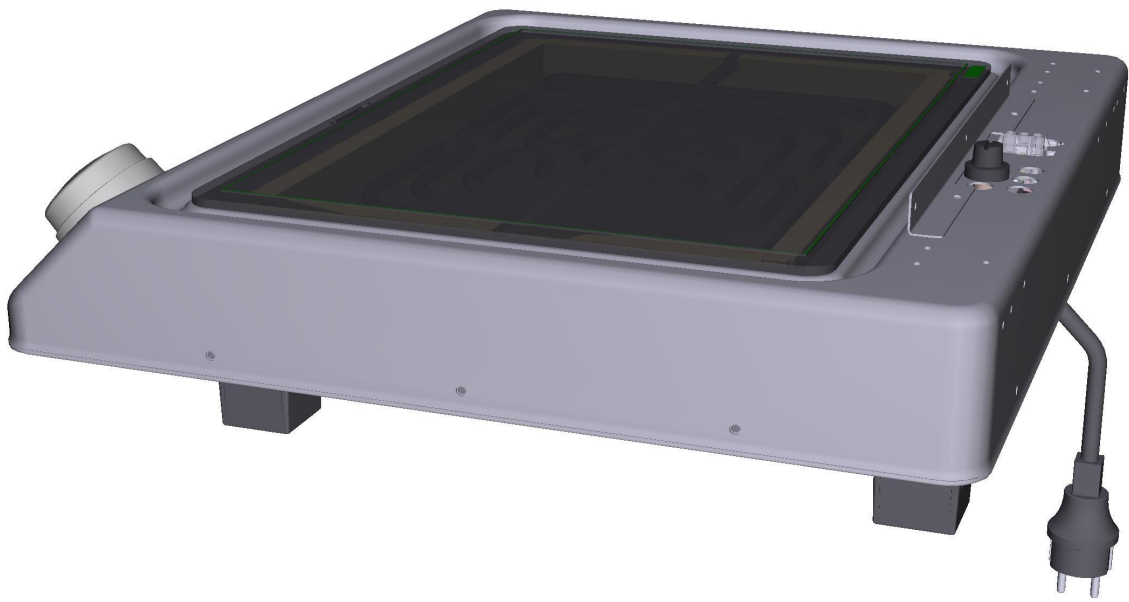

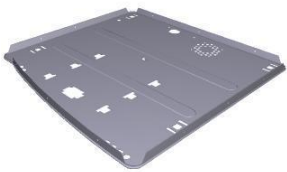

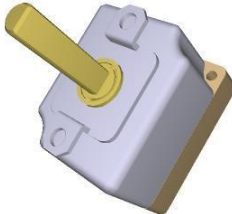
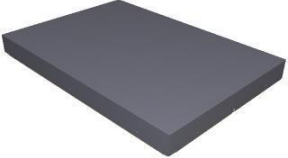
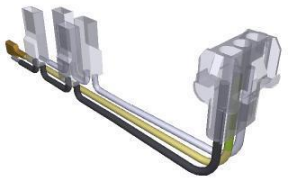
COMPONENT			SPARE PART																		
Code	Description	Image	Code	Description	Kit components																
0E1272A	SP015 ETERNAL PLATE BOTTOM PANEL		0E1272A0	SP015 ETERNAL PLATE BOTTOM PANEL																	
VM1776A	"GOLD ""0-1"" MATT SILVER KEY"		KVE0108A	0 - 1 SWITCH BUTTON KIT	<table border="1"> <thead> <tr> <th>Code</th> <th>Description</th> <th>Qty</th> <th>UOM</th> </tr> </thead> <tbody> <tr> <td>VE1170A0</td> <td>D16 OPAQUE NICKEL ELLIPTICAL SUPPORT</td> <td>2.000</td> <td>PC</td> </tr> <tr> <td>VE1561A0</td> <td>NA/NA BIPOLAR SWITCH</td> <td>1.000</td> <td>PC</td> </tr> <tr> <td>VM1776A0</td> <td>"GOLD ""0-1"" MATT SILVER KEY"</td> <td>1.000</td> <td>PC</td> </tr> </tbody> </table>	Code	Description	Qty	UOM	VE1170A0	D16 OPAQUE NICKEL ELLIPTICAL SUPPORT	2.000	PC	VE1561A0	NA/NA BIPOLAR SWITCH	1.000	PC	VM1776A0	"GOLD ""0-1"" MATT SILVER KEY"	1.000	PC
Code	Description	Qty	UOM																		
VE1170A0	D16 OPAQUE NICKEL ELLIPTICAL SUPPORT	2.000	PC																		
VE1561A0	NA/NA BIPOLAR SWITCH	1.000	PC																		
VM1776A0	"GOLD ""0-1"" MATT SILVER KEY"	1.000	PC																		
VM1750A	BRASS COMB CLAM		KVM1750A	COMB TERMINAL BLOCK KIT	<table border="1"> <thead> <tr> <th>Code</th> <th>Description</th> <th>Qty</th> <th>UOM</th> </tr> </thead> <tbody> <tr> <td>V11040A0</td> <td>INDENTED INTERNAL WASHER D=6 ZN</td> <td>2.000</td> <td>PC</td> </tr> <tr> <td>VM1750A0</td> <td>BRASS COMB CLAMP</td> <td>1.000</td> <td>PC</td> </tr> </tbody> </table>	Code	Description	Qty	UOM	V11040A0	INDENTED INTERNAL WASHER D=6 ZN	2.000	PC	VM1750A0	BRASS COMB CLAMP	1.000	PC				
Code	Description	Qty	UOM																		
V11040A0	INDENTED INTERNAL WASHER D=6 ZN	2.000	PC																		
VM1750A0	BRASS COMB CLAMP	1.000	PC																		
0D2472A	SP015 GRILL MECHANICAL BASE		0D2472A1	SP015 GRILL MECHANICAL BASE																	
MN1105B	MN1105B0		KMN1105B	120-400°C SP THERMOSTAT KNOB KIT	<table border="1"> <thead> <tr> <th>Code</th> <th>Description</th> <th>Qty</th> <th>UOM</th> </tr> </thead> <tbody> <tr> <td>MN1105B0</td> <td>MN1105B0</td> <td>1.000</td> <td>PC</td> </tr> </tbody> </table>	Code	Description	Qty	UOM	MN1105B0	MN1105B0	1.000	PC								
Code	Description	Qty	UOM																		
MN1105B0	MN1105B0	1.000	PC																		





COMPONENT			SPARE PART																														
Code	Description	Image	Code	Description	Kit components																												
MN1110B	SPIDOCOOK NEUTRAL INDEX DIA		KMN1110B	MANUAL SPIDOCOOK DIAL KI	<table border="1"> <thead> <tr> <th>Code</th> <th>Description</th> <th>Qty</th> <th>UOM</th> </tr> </thead> <tbody> <tr> <td>MN1110B0</td> <td>SPIDOCOOK NEUTRAL INDEX DIA</td> <td>1.000</td> <td>PC</td> </tr> </tbody> </table>	Code	Description	Qty	UOM	MN1110B0	SPIDOCOOK NEUTRAL INDEX DIA	1.000	PC																				
Code	Description	Qty	UOM																														
MN1110B0	SPIDOCOOK NEUTRAL INDEX DIA	1.000	PC																														
TR1131A	60-355°C THERMOSTAT		TR1131A0	60-355°C THERMOSTAT																													
RS1301A	RS1301A0		KRS1301A	SP015 1400W HEATING ELEMENT KIT	<table border="1"> <thead> <tr> <th>Code</th> <th>Description</th> <th>Qty</th> <th>UOM</th> </tr> </thead> <tbody> <tr> <td>RS1301A0</td> <td>RS1301A0</td> <td>1.000</td> <td>PC</td> </tr> <tr> <td>RS1305A0</td> <td>RS1305A0</td> <td>1.000</td> <td>PC</td> </tr> </tbody> </table>	Code	Description	Qty	UOM	RS1301A0	RS1301A0	1.000	PC	RS1305A0	RS1305A0	1.000	PC																
Code	Description	Qty	UOM																														
RS1301A0	RS1301A0	1.000	PC																														
RS1305A0	RS1305A0	1.000	PC																														
IE1518A	IE1518A0		KIE1518A	GRILL LOWER HEATING WIRING KI	<table border="1"> <thead> <tr> <th>Code</th> <th>Description</th> <th>Qty</th> <th>UOM</th> </tr> </thead> <tbody> <tr> <td>CE1030A0</td> <td>FEMALE FASTON COVER 6.3X0.8 0,5-1mmq</td> <td>1.000</td> <td>PC</td> </tr> <tr> <td>CE1155A0</td> <td>6,3x0,81 - 2,5 ALPACA FEMALE FASTON</td> <td>4.000</td> <td>PC</td> </tr> <tr> <td>CE1205A0</td> <td>FEMALE INAR-LOCK END CONNECTOR</td> <td>3.000</td> <td>PC</td> </tr> <tr> <td>CE1455A0</td> <td>TIP END FITTING</td> <td>2.000</td> <td>PC</td> </tr> <tr> <td>CE1485A0</td> <td>3 WAYS FEMALE INAR-LOCK CONNECTOR</td> <td>1.000</td> <td>PC</td> </tr> <tr> <td>CE1535A0</td> <td>YELLOW/GRE EN UNIP AWG18 ST.3135 WIRE</td> <td>0.650</td> <td>M</td> </tr> </tbody> </table>	Code	Description	Qty	UOM	CE1030A0	FEMALE FASTON COVER 6.3X0.8 0,5-1mmq	1.000	PC	CE1155A0	6,3x0,81 - 2,5 ALPACA FEMALE FASTON	4.000	PC	CE1205A0	FEMALE INAR-LOCK END CONNECTOR	3.000	PC	CE1455A0	TIP END FITTING	2.000	PC	CE1485A0	3 WAYS FEMALE INAR-LOCK CONNECTOR	1.000	PC	CE1535A0	YELLOW/GRE EN UNIP AWG18 ST.3135 WIRE	0.650	M
Code	Description	Qty	UOM																														
CE1030A0	FEMALE FASTON COVER 6.3X0.8 0,5-1mmq	1.000	PC																														
CE1155A0	6,3x0,81 - 2,5 ALPACA FEMALE FASTON	4.000	PC																														
CE1205A0	FEMALE INAR-LOCK END CONNECTOR	3.000	PC																														
CE1455A0	TIP END FITTING	2.000	PC																														
CE1485A0	3 WAYS FEMALE INAR-LOCK CONNECTOR	1.000	PC																														
CE1535A0	YELLOW/GRE EN UNIP AWG18 ST.3135 WIRE	0.650	M																														



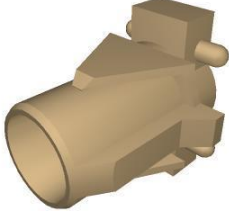

COMPONENT			SPARE PART																																										
Code	Description	Image	Code	Description	Kit components																																								
IE1518A	IE1518A0		KIE1518A	GRILL LOWER HEATING WIRING KI	<table border="1"> <thead> <tr> <th>Code</th> <th>Description</th> <th>Qty</th> <th>UOM</th> </tr> </thead> <tbody> <tr> <td>CE1625A1</td> <td>WHITE UNIP AWG16 ST.3135 WIRE</td> <td>1.500</td> <td>M</td> </tr> <tr> <td>CE1630A1</td> <td>BALCK UNIP AWG16 ST.3135 WIRE</td> <td>2.200</td> <td>M</td> </tr> <tr> <td>CE1660A0</td> <td>6,3x0,8 FEMALE FASTON COVE</td> <td>1.000</td> <td>PC</td> </tr> </tbody> </table>	Code	Description	Qty	UOM	CE1625A1	WHITE UNIP AWG16 ST.3135 WIRE	1.500	M	CE1630A1	BALCK UNIP AWG16 ST.3135 WIRE	2.200	M	CE1660A0	6,3x0,8 FEMALE FASTON COVE	1.000	PC																								
Code	Description	Qty	UOM																																										
CE1625A1	WHITE UNIP AWG16 ST.3135 WIRE	1.500	M																																										
CE1630A1	BALCK UNIP AWG16 ST.3135 WIRE	2.200	M																																										
CE1660A0	6,3x0,8 FEMALE FASTON COVE	1.000	PC																																										
VE1530A	GOLD THERMOMETER BLUE LIGHT COVER		KLP1012A	GOLDEN THERMOMETER BLUE LIGHT KIT	<table border="1"> <thead> <tr> <th>Code</th> <th>Description</th> <th>Qty</th> <th>UOM</th> </tr> </thead> <tbody> <tr> <td>VE1170A0</td> <td>D16 OPAQUE NICKEL ELLIPTICAL SUPPORT</td> <td>1.000</td> <td>PC</td> </tr> <tr> <td>VE1530A0</td> <td>GOLD THERMOMETE R BLUE LIGHT COVER</td> <td>1.000</td> <td>PC</td> </tr> <tr> <td>VE1535A1</td> <td>230V WHITE LED</td> <td>1.000</td> <td>PC</td> </tr> <tr> <td>VM1762A0</td> <td>INNER LAMP SUPPORT</td> <td>1.000</td> <td>PC</td> </tr> <tr> <td>VM2009A0</td> <td>D16 SILVER ELLIPTICAL SUPPORT</td> <td>1.000</td> <td>PC</td> </tr> </tbody> </table>	Code	Description	Qty	UOM	VE1170A0	D16 OPAQUE NICKEL ELLIPTICAL SUPPORT	1.000	PC	VE1530A0	GOLD THERMOMETE R BLUE LIGHT COVER	1.000	PC	VE1535A1	230V WHITE LED	1.000	PC	VM1762A0	INNER LAMP SUPPORT	1.000	PC	VM2009A0	D16 SILVER ELLIPTICAL SUPPORT	1.000	PC																
Code	Description	Qty	UOM																																										
VE1170A0	D16 OPAQUE NICKEL ELLIPTICAL SUPPORT	1.000	PC																																										
VE1530A0	GOLD THERMOMETE R BLUE LIGHT COVER	1.000	PC																																										
VE1535A1	230V WHITE LED	1.000	PC																																										
VM1762A0	INNER LAMP SUPPORT	1.000	PC																																										
VM2009A0	D16 SILVER ELLIPTICAL SUPPORT	1.000	PC																																										
VE1535A	230V WHITE LED		<p>KVE1535A</p> <p>KVE0105A</p> <p>KVE0104A</p>	<p>230V WHITE LED LIGHT 1 PC KIT</p> <p>CLOUD LED LIGHT+COVER+SUPPORT KIT</p> <p>NEUTRAL GREEN LIGHT KIT</p>	<table border="1"> <thead> <tr> <th>Code</th> <th>Description</th> <th>Qty</th> <th>UOM</th> </tr> </thead> <tbody> <tr> <td>VE1535A1</td> <td>230V WHITE LED</td> <td>1.000</td> <td>PC</td> </tr> <tr> <td>VE1170A0</td> <td>D16 OPAQUE NICKEL ELLIPTICAL SUPPORT</td> <td>1.000</td> <td>PC</td> </tr> <tr> <td>VE1535A1</td> <td>230V WHITE LED</td> <td>1.000</td> <td>PC</td> </tr> <tr> <td>VM1762A0</td> <td>INNER LAMP SUPPORT</td> <td>1.000</td> <td>PC</td> </tr> <tr> <td>VM1903A0</td> <td>GREEN PILOT WITH GOLD "CLOUD"</td> <td>1.000</td> <td>PC</td> </tr> <tr> <td>VE1170A0</td> <td>D16 OPAQUE NICKEL ELLIPTICAL SUPPORT</td> <td>1.000</td> <td>PC</td> </tr> <tr> <td>VE1535A1</td> <td>230V WHITE LED</td> <td>1.000</td> <td>PC</td> </tr> <tr> <td>VM1762A0</td> <td>INNER LAMP SUPPORT</td> <td>1.000</td> <td>PC</td> </tr> <tr> <td>VM1902A0</td> <td>NEUTRAL GREEN PLASTIC COVER FOR</td> <td>1.000</td> <td>PC</td> </tr> </tbody> </table>	Code	Description	Qty	UOM	VE1535A1	230V WHITE LED	1.000	PC	VE1170A0	D16 OPAQUE NICKEL ELLIPTICAL SUPPORT	1.000	PC	VE1535A1	230V WHITE LED	1.000	PC	VM1762A0	INNER LAMP SUPPORT	1.000	PC	VM1903A0	GREEN PILOT WITH GOLD "CLOUD"	1.000	PC	VE1170A0	D16 OPAQUE NICKEL ELLIPTICAL SUPPORT	1.000	PC	VE1535A1	230V WHITE LED	1.000	PC	VM1762A0	INNER LAMP SUPPORT	1.000	PC	VM1902A0	NEUTRAL GREEN PLASTIC COVER FOR	1.000	PC
Code	Description	Qty	UOM																																										
VE1535A1	230V WHITE LED	1.000	PC																																										
VE1170A0	D16 OPAQUE NICKEL ELLIPTICAL SUPPORT	1.000	PC																																										
VE1535A1	230V WHITE LED	1.000	PC																																										
VM1762A0	INNER LAMP SUPPORT	1.000	PC																																										
VM1903A0	GREEN PILOT WITH GOLD "CLOUD"	1.000	PC																																										
VE1170A0	D16 OPAQUE NICKEL ELLIPTICAL SUPPORT	1.000	PC																																										
VE1535A1	230V WHITE LED	1.000	PC																																										
VM1762A0	INNER LAMP SUPPORT	1.000	PC																																										
VM1902A0	NEUTRAL GREEN PLASTIC COVER FOR	1.000	PC																																										

COMPONENT			SPARE PART																							
Code	Description	Image	Code	Description	Kit components																					
VE1535A	230V WHITE LED		KVE0102A	GOLDEN FLAME LIGHT COVER KIT	<table border="1"> <thead> <tr> <th>Code</th> <th>Description</th> <th>Qty</th> <th>UOM</th> </tr> </thead> <tbody> <tr> <td>VE1170A0</td> <td>D16 OPAQUE NICKEL ELLIPTICAL SUPPORT</td> <td>1.000</td> <td>PC</td> </tr> <tr> <td>VE1535A1</td> <td>230V WHITE LED</td> <td>1.000</td> <td>PC</td> </tr> <tr> <td>VM1762A0</td> <td>INNER LAMP SUPPORT</td> <td>1.000</td> <td>PC</td> </tr> <tr> <td>VM1767A0</td> <td>GREEN PILOT LIGHT W/ GOLD FLAME</td> <td>1.000</td> <td>PC</td> </tr> </tbody> </table>	Code	Description	Qty	UOM	VE1170A0	D16 OPAQUE NICKEL ELLIPTICAL SUPPORT	1.000	PC	VE1535A1	230V WHITE LED	1.000	PC	VM1762A0	INNER LAMP SUPPORT	1.000	PC	VM1767A0	GREEN PILOT LIGHT W/ GOLD FLAME	1.000	PC	
			Code	Description	Qty	UOM																				
			VE1170A0	D16 OPAQUE NICKEL ELLIPTICAL SUPPORT	1.000	PC																				
			VE1535A1	230V WHITE LED	1.000	PC																				
			VM1762A0	INNER LAMP SUPPORT	1.000	PC																				
			VM1767A0	GREEN PILOT LIGHT W/ GOLD FLAME	1.000	PC																				
			KVE0101A	SINUSOID LIGHT GREEN COVER KIT	<table border="1"> <thead> <tr> <th>Code</th> <th>Description</th> <th>Qty</th> <th>UOM</th> </tr> </thead> <tbody> <tr> <td>VE1170A0</td> <td>D16 OPAQUE NICKEL ELLIPTICAL SUPPORT</td> <td>1.000</td> <td>PC</td> </tr> <tr> <td>VE1535A1</td> <td>230V WHITE LED</td> <td>1.000</td> <td>PC</td> </tr> <tr> <td>VM1762A0</td> <td>INNER LAMP SUPPORT</td> <td>1.000</td> <td>PC</td> </tr> <tr> <td>VM1765A0</td> <td>GREEN PILOT WITH GOLD SINUSOIDE</td> <td>1.000</td> <td>PC</td> </tr> </tbody> </table>	Code	Description	Qty	UOM	VE1170A0	D16 OPAQUE NICKEL ELLIPTICAL SUPPORT	1.000	PC	VE1535A1	230V WHITE LED	1.000	PC	VM1762A0	INNER LAMP SUPPORT	1.000	PC	VM1765A0	GREEN PILOT WITH GOLD SINUSOIDE	1.000	PC	
			Code	Description	Qty	UOM																				
			VE1170A0	D16 OPAQUE NICKEL ELLIPTICAL SUPPORT	1.000	PC																				
			VE1535A1	230V WHITE LED	1.000	PC																				
			VM1762A0	INNER LAMP SUPPORT	1.000	PC																				
			VM1765A0	GREEN PILOT WITH GOLD SINUSOIDE	1.000	PC																				
KVE0100A	THERMOMETER LIGHT COVER KIT	<table border="1"> <thead> <tr> <th>Code</th> <th>Description</th> <th>Qty</th> <th>UOM</th> </tr> </thead> <tbody> <tr> <td>VE1530A0</td> <td>GOLD THERMOMETE R BLUE LIGHT COVER</td> <td>1.000</td> <td>PC</td> </tr> <tr> <td>VE1535A1</td> <td>230V WHITE LED</td> <td>1.000</td> <td>PC</td> </tr> <tr> <td>VM1761A0</td> <td>D16 BLACK ELLIPTICAL SUPPORT</td> <td>1.000</td> <td>PC</td> </tr> <tr> <td>VM1762A0</td> <td>INNER LAMP SUPPORT</td> <td>1.000</td> <td>PC</td> </tr> </tbody> </table>	Code	Description	Qty	UOM	VE1530A0	GOLD THERMOMETE R BLUE LIGHT COVER	1.000	PC	VE1535A1	230V WHITE LED	1.000	PC	VM1761A0	D16 BLACK ELLIPTICAL SUPPORT	1.000	PC	VM1762A0	INNER LAMP SUPPORT	1.000	PC				
Code	Description	Qty	UOM																							
VE1530A0	GOLD THERMOMETE R BLUE LIGHT COVER	1.000	PC																							
VE1535A1	230V WHITE LED	1.000	PC																							
VM1761A0	D16 BLACK ELLIPTICAL SUPPORT	1.000	PC																							
VM1762A0	INNER LAMP SUPPORT	1.000	PC																							
KVE0011A	SP KNOBS AND LIGHTS KIT	<table border="1"> <thead> <tr> <th>Code</th> <th>Description</th> <th>Qty</th> <th>UOM</th> </tr> </thead> <tbody> <tr> <td>MN1105A0</td> <td>120-400C XP THERMOSTAT KNOB</td> <td>1.000</td> <td>PC</td> </tr> <tr> <td>MN1110A0</td> <td>XP NEUTRAL INDEX DIAL</td> <td>1.000</td> <td>PC</td> </tr> <tr> <td>VE1530A0</td> <td>GOLD THERMOMETE R BLUE LIGHT COVER</td> <td>1.000</td> <td>PC</td> </tr> <tr> <td>VE1535A1</td> <td>230V WHITE LED</td> <td>1.000</td> <td>PC</td> </tr> <tr> <td>VE1561A0</td> <td>NA/NA BIPOLAR SWITCH</td> <td>1.000</td> <td>PC</td> </tr> </tbody> </table>	Code	Description	Qty	UOM	MN1105A0	120-400C XP THERMOSTAT KNOB	1.000	PC	MN1110A0	XP NEUTRAL INDEX DIAL	1.000	PC	VE1530A0	GOLD THERMOMETE R BLUE LIGHT COVER	1.000	PC	VE1535A1	230V WHITE LED	1.000	PC	VE1561A0	NA/NA BIPOLAR SWITCH	1.000	PC
Code	Description	Qty	UOM																							
MN1105A0	120-400C XP THERMOSTAT KNOB	1.000	PC																							
MN1110A0	XP NEUTRAL INDEX DIAL	1.000	PC																							
VE1530A0	GOLD THERMOMETE R BLUE LIGHT COVER	1.000	PC																							
VE1535A1	230V WHITE LED	1.000	PC																							
VE1561A0	NA/NA BIPOLAR SWITCH	1.000	PC																							

COMPONENT			SPARE PART																																			
Code	Description	Image	Code	Description	Kit components																																	
VE1535A	230V WHITE LED		KVE0011A	SP KNOBS AND LIGHTS KIT	<table border="1"> <thead> <tr> <th>Code</th> <th>Description</th> <th>Qty</th> <th>UOM</th> </tr> </thead> <tbody> <tr> <td>VM1761A0</td> <td>D16 BLACK ELLIPTICAL SUPPORT</td> <td>2.000</td> <td>PC</td> </tr> <tr> <td>VM1762A0</td> <td>INNER LAMP SUPPORT</td> <td>1.000</td> <td>PC</td> </tr> <tr> <td>VM1776A0</td> <td>"GOLD "0-1"" MATT SILVER KEY"</td> <td>1.000</td> <td>PC</td> </tr> </tbody> </table>	Code	Description	Qty	UOM	VM1761A0	D16 BLACK ELLIPTICAL SUPPORT	2.000	PC	VM1762A0	INNER LAMP SUPPORT	1.000	PC	VM1776A0	"GOLD "0-1"" MATT SILVER KEY"	1.000	PC																	
			Code	Description	Qty	UOM																																
			VM1761A0	D16 BLACK ELLIPTICAL SUPPORT	2.000	PC																																
VM1762A0	INNER LAMP SUPPORT	1.000	PC																																			
VM1776A0	"GOLD "0-1"" MATT SILVER KEY"	1.000	PC																																			
KVE0008A	XL PILOT BLUE LIGHTS KIT	<table border="1"> <thead> <tr> <th>Code</th> <th>Description</th> <th>Qty</th> <th>UOM</th> </tr> </thead> <tbody> <tr> <td>VE1170A0</td> <td>D16 OPAQUE NICKEL ELLIPTICAL SUPPORT</td> <td>3.000</td> <td>PC</td> </tr> <tr> <td>VE1530A0</td> <td>GOLD THERMOMETE R BLUE LIGHT COVER</td> <td>1.000</td> <td>PC</td> </tr> <tr> <td>VE1535A1</td> <td>230V WHITE LED</td> <td>1.000</td> <td>PC</td> </tr> <tr> <td>VE1561A0</td> <td>NA/NA BIPOLAR SWITCH</td> <td>1.000</td> <td>PC</td> </tr> <tr> <td>VE1562A0</td> <td>UNIPOLAR NA PUSH BUTTO</td> <td>1.000</td> <td>PC</td> </tr> <tr> <td>VM1762A0</td> <td>INNER LAMP SUPPORT</td> <td>1.000</td> <td>PC</td> </tr> <tr> <td>VM1775A0</td> <td>OPAQUE SILVER KEY WITH GOLD CLOUD</td> <td>1.000</td> <td>PC</td> </tr> <tr> <td>VM1776A0</td> <td>"GOLD "0-1"" MATT SILVER KEY"</td> <td>1.000</td> <td>PC</td> </tr> </tbody> </table>	Code	Description	Qty	UOM	VE1170A0	D16 OPAQUE NICKEL ELLIPTICAL SUPPORT	3.000	PC	VE1530A0	GOLD THERMOMETE R BLUE LIGHT COVER	1.000	PC	VE1535A1	230V WHITE LED	1.000	PC	VE1561A0	NA/NA BIPOLAR SWITCH	1.000	PC	VE1562A0	UNIPOLAR NA PUSH BUTTO	1.000	PC	VM1762A0	INNER LAMP SUPPORT	1.000	PC	VM1775A0	OPAQUE SILVER KEY WITH GOLD CLOUD	1.000	PC	VM1776A0	"GOLD "0-1"" MATT SILVER KEY"	1.000	PC
Code	Description	Qty	UOM																																			
VE1170A0	D16 OPAQUE NICKEL ELLIPTICAL SUPPORT	3.000	PC																																			
VE1530A0	GOLD THERMOMETE R BLUE LIGHT COVER	1.000	PC																																			
VE1535A1	230V WHITE LED	1.000	PC																																			
VE1561A0	NA/NA BIPOLAR SWITCH	1.000	PC																																			
VE1562A0	UNIPOLAR NA PUSH BUTTO	1.000	PC																																			
VM1762A0	INNER LAMP SUPPORT	1.000	PC																																			
VM1775A0	OPAQUE SILVER KEY WITH GOLD CLOUD	1.000	PC																																			
VM1776A0	"GOLD "0-1"" MATT SILVER KEY"	1.000	PC																																			
KVE0007A	XF-XG LED AND LED COVERS KIT	<table border="1"> <thead> <tr> <th>Code</th> <th>Description</th> <th>Qty</th> <th>UOM</th> </tr> </thead> <tbody> <tr> <td>VE1170A0</td> <td>D16 OPAQUE NICKEL ELLIPTICAL SUPPORT</td> <td>5.000</td> <td>PC</td> </tr> <tr> <td>VE1530A0</td> <td>GOLD THERMOMETE R BLUE LIGHT COVER</td> <td>1.000</td> <td>PC</td> </tr> <tr> <td>VE1535A1</td> <td>230V WHITE LED</td> <td>1.000</td> <td>PC</td> </tr> <tr> <td>VE1562A0</td> <td>UNIPOLAR NA PUSH BUTTO</td> <td>1.000</td> <td>PC</td> </tr> <tr> <td>VE1585A0</td> <td>BLUE LIGHT COVER GOLD SINUSOID</td> <td>1.000</td> <td>PC</td> </tr> <tr> <td>VM1762A0</td> <td>INNER LAMP SUPPORT</td> <td>4.000</td> <td>PC</td> </tr> </tbody> </table>	Code	Description	Qty	UOM	VE1170A0	D16 OPAQUE NICKEL ELLIPTICAL SUPPORT	5.000	PC	VE1530A0	GOLD THERMOMETE R BLUE LIGHT COVER	1.000	PC	VE1535A1	230V WHITE LED	1.000	PC	VE1562A0	UNIPOLAR NA PUSH BUTTO	1.000	PC	VE1585A0	BLUE LIGHT COVER GOLD SINUSOID	1.000	PC	VM1762A0	INNER LAMP SUPPORT	4.000	PC								
Code	Description	Qty	UOM																																			
VE1170A0	D16 OPAQUE NICKEL ELLIPTICAL SUPPORT	5.000	PC																																			
VE1530A0	GOLD THERMOMETE R BLUE LIGHT COVER	1.000	PC																																			
VE1535A1	230V WHITE LED	1.000	PC																																			
VE1562A0	UNIPOLAR NA PUSH BUTTO	1.000	PC																																			
VE1585A0	BLUE LIGHT COVER GOLD SINUSOID	1.000	PC																																			
VM1762A0	INNER LAMP SUPPORT	4.000	PC																																			

COMPONENT			SPARE PART																										
Code	Description	Image	Code	Description	Kit components																								
VE1535A	230V WHITE LED		KVE0007A	XF-XG LED AND LED COVERS KIT	<table border="1"> <thead> <tr> <th>Code</th> <th>Description</th> <th>Qty</th> <th>UOM</th> </tr> </thead> <tbody> <tr> <td>VM1787A0</td> <td>GREEN PILOT LIGHT W/ GOLD FLAME</td> <td>1.000</td> <td>PC</td> </tr> <tr> <td>VM1774A0</td> <td>SILVER OPAQUE KEY W/ GOLD FLAME</td> <td>1.000</td> <td>PC</td> </tr> <tr> <td>VM1775A0</td> <td>OPAQUE SILVER KEY WITH GOLD CLOUD</td> <td>1.000</td> <td>PC</td> </tr> <tr> <td>VM1902A0</td> <td>NEUTRAL GREEN PLASTIC COVER FOR</td> <td>1.000</td> <td>PC</td> </tr> <tr> <td>VM1903A0</td> <td>GREEN PILOT WITH GOLD "CLOUD"</td> <td>1.000</td> <td>PC</td> </tr> </tbody> </table>	Code	Description	Qty	UOM	VM1787A0	GREEN PILOT LIGHT W/ GOLD FLAME	1.000	PC	VM1774A0	SILVER OPAQUE KEY W/ GOLD FLAME	1.000	PC	VM1775A0	OPAQUE SILVER KEY WITH GOLD CLOUD	1.000	PC	VM1902A0	NEUTRAL GREEN PLASTIC COVER FOR	1.000	PC	VM1903A0	GREEN PILOT WITH GOLD "CLOUD"	1.000	PC
			Code	Description	Qty	UOM																							
			VM1787A0	GREEN PILOT LIGHT W/ GOLD FLAME	1.000	PC																							
			VM1774A0	SILVER OPAQUE KEY W/ GOLD FLAME	1.000	PC																							
			VM1775A0	OPAQUE SILVER KEY WITH GOLD CLOUD	1.000	PC																							
			VM1902A0	NEUTRAL GREEN PLASTIC COVER FOR	1.000	PC																							
			VM1903A0	GREEN PILOT WITH GOLD "CLOUD"	1.000	PC																							
			KLP1014A	SINUSOID LED LIGHT+COVER+SUPPORT KIT	<table border="1"> <thead> <tr> <th>Code</th> <th>Description</th> <th>Qty</th> <th>UOM</th> </tr> </thead> <tbody> <tr> <td>VE1170A0</td> <td>D16 OPAQUE NICKEL ELLIPTICAL SUPPORT</td> <td>2.000</td> <td>PC</td> </tr> <tr> <td>VE1535A1</td> <td>230V WHITE LED</td> <td>2.000</td> <td>PC</td> </tr> <tr> <td>VE1585A0</td> <td>BLUE LIGHT COVER GOLD SINUSOID</td> <td>2.000</td> <td>PC</td> </tr> <tr> <td>VM1762A0</td> <td>INNER LAMP SUPPORT</td> <td>2.000</td> <td>PC</td> </tr> <tr> <td>VM2009A0</td> <td>D16 SILVER ELLIPTICAL SUPPORT</td> <td>1.000</td> <td>PC</td> </tr> </tbody> </table>	Code	Description	Qty	UOM	VE1170A0	D16 OPAQUE NICKEL ELLIPTICAL SUPPORT	2.000	PC	VE1535A1	230V WHITE LED	2.000	PC	VE1585A0	BLUE LIGHT COVER GOLD SINUSOID	2.000	PC	VM1762A0	INNER LAMP SUPPORT	2.000	PC	VM2009A0	D16 SILVER ELLIPTICAL SUPPORT	1.000	PC
			Code	Description	Qty	UOM																							
			VE1170A0	D16 OPAQUE NICKEL ELLIPTICAL SUPPORT	2.000	PC																							
			VE1535A1	230V WHITE LED	2.000	PC																							
			VE1585A0	BLUE LIGHT COVER GOLD SINUSOID	2.000	PC																							
			VM1762A0	INNER LAMP SUPPORT	2.000	PC																							
			VM2009A0	D16 SILVER ELLIPTICAL SUPPORT	1.000	PC																							
			KLP1012A	GOLDEN THERMOMETER BLUE LIGHT KIT	<table border="1"> <thead> <tr> <th>Code</th> <th>Description</th> <th>Qty</th> <th>UOM</th> </tr> </thead> <tbody> <tr> <td>VE1170A0</td> <td>D16 OPAQUE NICKEL ELLIPTICAL SUPPORT</td> <td>1.000</td> <td>PC</td> </tr> <tr> <td>VE1530A0</td> <td>GOLD THERMOMETE R BLUE LIGHT COVER</td> <td>1.000</td> <td>PC</td> </tr> <tr> <td>VE1535A1</td> <td>230V WHITE LED</td> <td>1.000</td> <td>PC</td> </tr> <tr> <td>VM1762A0</td> <td>INNER LAMP SUPPORT</td> <td>1.000</td> <td>PC</td> </tr> <tr> <td>VM2009A0</td> <td>D16 SILVER ELLIPTICAL SUPPORT</td> <td>1.000</td> <td>PC</td> </tr> </tbody> </table>	Code	Description	Qty	UOM	VE1170A0	D16 OPAQUE NICKEL ELLIPTICAL SUPPORT	1.000	PC	VE1530A0	GOLD THERMOMETE R BLUE LIGHT COVER	1.000	PC	VE1535A1	230V WHITE LED	1.000	PC	VM1762A0	INNER LAMP SUPPORT	1.000	PC	VM2009A0	D16 SILVER ELLIPTICAL SUPPORT	1.000	PC
Code	Description	Qty	UOM																										
VE1170A0	D16 OPAQUE NICKEL ELLIPTICAL SUPPORT	1.000	PC																										
VE1530A0	GOLD THERMOMETE R BLUE LIGHT COVER	1.000	PC																										
VE1535A1	230V WHITE LED	1.000	PC																										
VM1762A0	INNER LAMP SUPPORT	1.000	PC																										
VM2009A0	D16 SILVER ELLIPTICAL SUPPORT	1.000	PC																										

COMPONENT			SPARE PART																						
Code	Description	Image	Code	Description	Kit components																				
VE1535A	230V WHITE LED		KLP1010A	THERMOSTAT GREEN LIGHT KIT	<table border="1"> <thead> <tr> <th>Code</th> <th>Description</th> <th>Qty</th> <th>UOM</th> </tr> </thead> <tbody> <tr> <td>VE1170A0</td> <td>D16 OPAQUE NICKEL ELLIPTICAL SUPPORT</td> <td>1.000</td> <td>PC</td> </tr> <tr> <td>VE1535A1</td> <td>230V WHITE LED</td> <td>1.000</td> <td>PC</td> </tr> <tr> <td>VM1762A0</td> <td>INNER LAMP SUPPORT</td> <td>1.000</td> <td>PC</td> </tr> <tr> <td>VM1764A0</td> <td>GREEN PILOT WITH GOLD THERMOMETE</td> <td>1.000</td> <td>PC</td> </tr> </tbody> </table>	Code	Description	Qty	UOM	VE1170A0	D16 OPAQUE NICKEL ELLIPTICAL SUPPORT	1.000	PC	VE1535A1	230V WHITE LED	1.000	PC	VM1762A0	INNER LAMP SUPPORT	1.000	PC	VM1764A0	GREEN PILOT WITH GOLD THERMOMETE	1.000	PC
					Code	Description	Qty	UOM																	
					VE1170A0	D16 OPAQUE NICKEL ELLIPTICAL SUPPORT	1.000	PC																	
					VE1535A1	230V WHITE LED	1.000	PC																	
VM1762A0	INNER LAMP SUPPORT	1.000	PC																						
VM1764A0	GREEN PILOT WITH GOLD THERMOMETE	1.000	PC																						
<table border="1"> <thead> <tr> <th>Code</th> <th>Description</th> <th>Qty</th> <th>UOM</th> </tr> </thead> <tbody> <tr> <td>VM1762A0</td> <td>INNER LAMP SUPPORT</td> <td>1.000</td> <td>PC</td> </tr> </tbody> </table>	Code	Description	Qty	UOM	VM1762A0	INNER LAMP SUPPORT	1.000	PC																	
Code	Description	Qty	UOM																						
VM1762A0	INNER LAMP SUPPORT	1.000	PC																						
<table border="1"> <thead> <tr> <th>Code</th> <th>Description</th> <th>Qty</th> <th>UOM</th> </tr> </thead> <tbody> <tr> <td>MR1000A0</td> <td>CABLE 3x1,5 H07RN-F MT1,5+K2/3+SCHUK</td> <td>1.000</td> <td>PC</td> </tr> </tbody> </table>	Code	Description	Qty	UOM	MR1000A0	CABLE 3x1,5 H07RN-F MT1,5+K2/3+SCHUK	1.000	PC																	
Code	Description	Qty	UOM																						
MR1000A0	CABLE 3x1,5 H07RN-F MT1,5+K2/3+SCHUK	1.000	PC																						
<table border="1"> <thead> <tr> <th>Code</th> <th>Description</th> <th>Qty</th> <th>UOM</th> </tr> </thead> <tbody> <tr> <td>PD1001A0</td> <td>35x35 H26 GREY PLASTIC+RUBBER FOOT</td> <td>4.000</td> <td>PC</td> </tr> </tbody> </table>	Code	Description	Qty	UOM	PD1001A0	35x35 H26 GREY PLASTIC+RUBBER FOOT	4.000	PC																	
Code	Description	Qty	UOM																						
PD1001A0	35x35 H26 GREY PLASTIC+RUBBER FOOT	4.000	PC																						
VM1762A	INNER LAMP SUPPORT		KVM1762A	LAMP INTERNAL SUPPORT KIT	<table border="1"> <thead> <tr> <th>Code</th> <th>Description</th> <th>Qty</th> <th>UOM</th> </tr> </thead> <tbody> <tr> <td>VM1762A0</td> <td>INNER LAMP SUPPORT</td> <td>1.000</td> <td>PC</td> </tr> </tbody> </table>	Code	Description	Qty	UOM	VM1762A0	INNER LAMP SUPPORT	1.000	PC												
Code	Description	Qty	UOM																						
VM1762A0	INNER LAMP SUPPORT	1.000	PC																						
MR1000A	CABLE 3x1,5 H07RN-F MT1,5+K2/3+SCHUK		KMR1000A	KIT CABLE 3X1,5 H07RN-F +K2/3+SCHUKO	<table border="1"> <thead> <tr> <th>Code</th> <th>Description</th> <th>Qty</th> <th>UOM</th> </tr> </thead> <tbody> <tr> <td>MR1000A0</td> <td>CABLE 3x1,5 H07RN-F MT1,5+K2/3+SCHUKO</td> <td>1.000</td> <td>PC</td> </tr> </tbody> </table>	Code	Description	Qty	UOM	MR1000A0	CABLE 3x1,5 H07RN-F MT1,5+K2/3+SCHUKO	1.000	PC												
Code	Description	Qty	UOM																						
MR1000A0	CABLE 3x1,5 H07RN-F MT1,5+K2/3+SCHUKO	1.000	PC																						
PD1001A	35x35 H26 GREY PLASTIC+RUBBER FOOT		KPD1001A	35x35 H26 FEET 4 PCS KIT	<table border="1"> <thead> <tr> <th>Code</th> <th>Description</th> <th>Qty</th> <th>UOM</th> </tr> </thead> <tbody> <tr> <td>PD1001A0</td> <td>35x35 H26 GREY PLASTIC+RUBBER FOOT</td> <td>4.000</td> <td>PC</td> </tr> </tbody> </table>	Code	Description	Qty	UOM	PD1001A0	35x35 H26 GREY PLASTIC+RUBBER FOOT	4.000	PC												
Code	Description	Qty	UOM																						
PD1001A0	35x35 H26 GREY PLASTIC+RUBBER FOOT	4.000	PC																						
TR1136A	318°C -0/+24 1 POLE SAFETY THERMOSTAT		KTR1136A	318°C -0/+24 SAFETY THERMOSTAT KIT	<table border="1"> <thead> <tr> <th>Code</th> <th>Description</th> <th>Qty</th> <th>UOM</th> </tr> </thead> <tbody> <tr> <td>0H8120A0</td> <td>XEVL BULB PASS-THROUGH COVER</td> <td>1.000</td> <td>PC</td> </tr> <tr> <td>GN1531A0</td> <td>THERMOSTAT BULB INLET SEALING</td> <td>1.000</td> <td>PC</td> </tr> <tr> <td>SL1045A0</td> <td>S57 BLACK SILICONE - 80ml CARTRIDGE</td> <td>1.000</td> <td>PC</td> </tr> </tbody> </table>	Code	Description	Qty	UOM	0H8120A0	XEVL BULB PASS-THROUGH COVER	1.000	PC	GN1531A0	THERMOSTAT BULB INLET SEALING	1.000	PC	SL1045A0	S57 BLACK SILICONE - 80ml CARTRIDGE	1.000	PC				
					Code	Description	Qty	UOM																	
					0H8120A0	XEVL BULB PASS-THROUGH COVER	1.000	PC																	
GN1531A0	THERMOSTAT BULB INLET SEALING	1.000	PC																						
SL1045A0	S57 BLACK SILICONE - 80ml CARTRIDGE	1.000	PC																						
<table border="1"> <thead> <tr> <th>Code</th> <th>Description</th> <th>Qty</th> <th>UOM</th> </tr> </thead> <tbody> <tr> <td>GN1531A0</td> <td>THERMOSTAT BULB INLET SEALING</td> <td>1.000</td> <td>PC</td> </tr> </tbody> </table>	Code	Description	Qty	UOM	GN1531A0	THERMOSTAT BULB INLET SEALING	1.000	PC																	
Code	Description	Qty	UOM																						
GN1531A0	THERMOSTAT BULB INLET SEALING	1.000	PC																						
<table border="1"> <thead> <tr> <th>Code</th> <th>Description</th> <th>Qty</th> <th>UOM</th> </tr> </thead> <tbody> <tr> <td>SL1045A0</td> <td>S57 BLACK SILICONE - 80ml CARTRIDGE</td> <td>1.000</td> <td>PC</td> </tr> </tbody> </table>	Code	Description	Qty	UOM	SL1045A0	S57 BLACK SILICONE - 80ml CARTRIDGE	1.000	PC																	
Code	Description	Qty	UOM																						
SL1045A0	S57 BLACK SILICONE - 80ml CARTRIDGE	1.000	PC																						

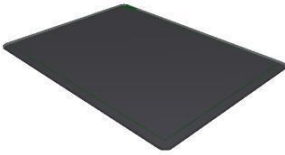

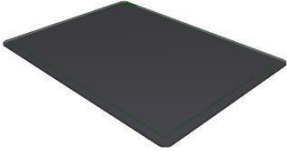

COMPONENT			SPARE PART																		
Code	Description	Image	Code	Description	Kit components																
TR1136A	318°C -0/+24 1 POLE SAFETY THERMOSTAT		KTR1136A	318°C -0/+24 SAFETY THERMOSTAT KIT	<table border="1"> <thead> <tr> <th>Code</th> <th>Description</th> <th>Qty</th> <th>UOM</th> </tr> </thead> <tbody> <tr> <td>TR1136A0</td> <td>318°C -0/+24 1 POLE SAFETY THERMOSTAT</td> <td>1.000</td> <td>PC</td> </tr> <tr> <td>VI1220A1</td> <td>4,2x12 TCB SELF-TAPPING SCREW</td> <td>3.000</td> <td>PC</td> </tr> </tbody> </table>	Code	Description	Qty	UOM	TR1136A0	318°C -0/+24 1 POLE SAFETY THERMOSTAT	1.000	PC	VI1220A1	4,2x12 TCB SELF-TAPPING SCREW	3.000	PC				
Code	Description	Qty	UOM																		
TR1136A0	318°C -0/+24 1 POLE SAFETY THERMOSTAT	1.000	PC																		
VI1220A1	4,2x12 TCB SELF-TAPPING SCREW	3.000	PC																		
VM1315A	XP FAT DRAIN		KVM1315A	XP FAT DRAIN KIT VM1315A	<table border="1"> <thead> <tr> <th>Code</th> <th>Description</th> <th>Qty</th> <th>UOM</th> </tr> </thead> <tbody> <tr> <td>VM1315A0</td> <td>XP FAT DRAIN</td> <td>1.000</td> <td>PC</td> </tr> </tbody> </table>	Code	Description	Qty	UOM	VM1315A0	XP FAT DRAIN	1.000	PC								
Code	Description	Qty	UOM																		
VM1315A0	XP FAT DRAIN	1.000	PC																		
VM1545A	CONTACT GRILL DRIP TRAY		KVM1545A	DRIP TRAY FOR XP CONTACT GRILL KIT	<table border="1"> <thead> <tr> <th>Code</th> <th>Description</th> <th>Qty</th> <th>UOM</th> </tr> </thead> <tbody> <tr> <td>VM1545A1</td> <td>CONTACT GRILL DRIP TRAY</td> <td>1.000</td> <td>PC</td> </tr> </tbody> </table>	Code	Description	Qty	UOM	VM1545A1	CONTACT GRILL DRIP TRAY	1.000	PC								
Code	Description	Qty	UOM																		
VM1545A1	CONTACT GRILL DRIP TRAY	1.000	PC																		
VM1546A	CONTACT GRILL DRIP TRAY GUIDE		KVM1546A	DIP TRAY GUIDE KIT	<table border="1"> <thead> <tr> <th>Code</th> <th>Description</th> <th>Qty</th> <th>UOM</th> </tr> </thead> <tbody> <tr> <td>VM1546A0</td> <td>CONTACT GRILL DRIP TRAY GUIDE</td> <td>1.000</td> <td>PC</td> </tr> </tbody> </table>	Code	Description	Qty	UOM	VM1546A0	CONTACT GRILL DRIP TRAY GUIDE	1.000	PC								
Code	Description	Qty	UOM																		
VM1546A0	CONTACT GRILL DRIP TRAY GUIDE	1.000	PC																		
VT1370B	TRANSPARENT SMOOTH CERAMIC GLASS SP015		<p>KVT1389AB</p> <p>KVT1389A</p>	<p>SP015 SMOOTH INF BLACK GLASS KIT</p> <p>SP015 SMOOTH UPP BLACK GLASS KIT</p>	<table border="1"> <thead> <tr> <th>Code</th> <th>Description</th> <th>Qty</th> <th>UOM</th> </tr> </thead> <tbody> <tr> <td>SL1045A0</td> <td>S57 BLACK SILICONE - 80ml CARTRIDGE</td> <td>1.000</td> <td>PC</td> </tr> <tr> <td>VT1389A0</td> <td>SP015 SMOOTH GLASS CERAMIC</td> <td>1.000</td> <td>PC</td> </tr> <tr> <td>0D2012B0</td> <td>SP015 UPPER HEATING ELEMENT BOX</td> <td>1.000</td> <td>PC</td> </tr> </tbody> </table>	Code	Description	Qty	UOM	SL1045A0	S57 BLACK SILICONE - 80ml CARTRIDGE	1.000	PC	VT1389A0	SP015 SMOOTH GLASS CERAMIC	1.000	PC	0D2012B0	SP015 UPPER HEATING ELEMENT BOX	1.000	PC
Code	Description	Qty	UOM																		
SL1045A0	S57 BLACK SILICONE - 80ml CARTRIDGE	1.000	PC																		
VT1389A0	SP015 SMOOTH GLASS CERAMIC	1.000	PC																		
0D2012B0	SP015 UPPER HEATING ELEMENT BOX	1.000	PC																		

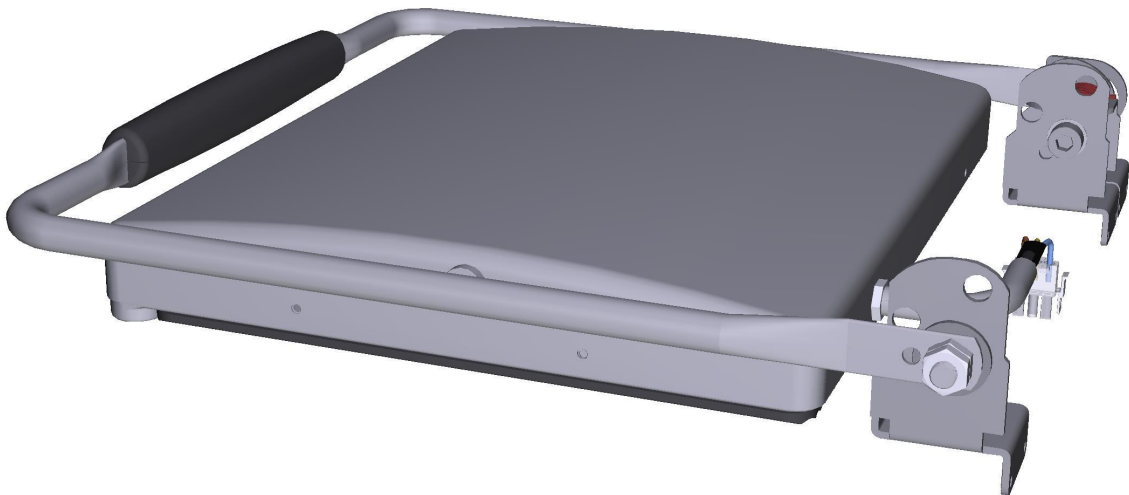

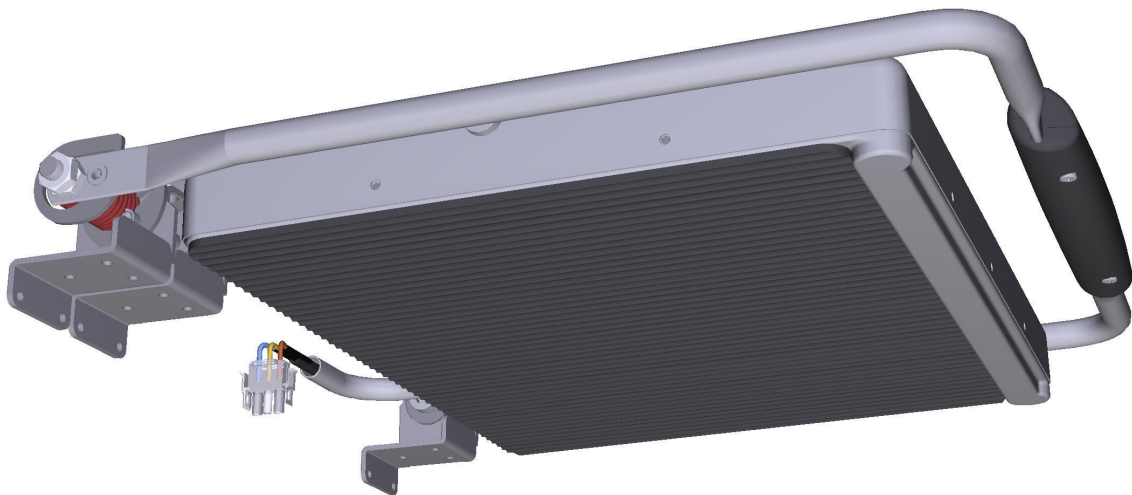
COMPONENT			SPARE PART																																																							
Code	Description	Image	Code	Description	Kit components																																																					
VT1370B	TRANSPARENT SMOOTH CERAMIC GLASS SP015		KVT1389A	SP015 SMOOTH UPP BLACK GLASS KIT	<table border="1"> <thead> <tr> <th>Code</th> <th>Description</th> <th>Qty</th> <th>UOM</th> </tr> </thead> <tbody> <tr> <td>0D2013B0</td> <td>SP015 GRILL UPPER GLASS SUPPORT</td> <td>1.000</td> <td>PC</td> </tr> <tr> <td>0H4183A1</td> <td>SP015 GRILL FAN GUARD COUNTER BRACKET</td> <td>1.000</td> <td>PC</td> </tr> <tr> <td>SL1171A1</td> <td>SILICON ANTHRACITE S57 BARREL</td> <td>0.010</td> <td>ML</td> </tr> <tr> <td>TB1517A0</td> <td>TB1517A0</td> <td>1.000</td> <td>PC</td> </tr> <tr> <td>VI1220A1</td> <td>4,2x12 TCB SELF-TAPPIN G SCREW</td> <td>9.000</td> <td>PC</td> </tr> <tr> <td>VI1605A0</td> <td>BUSHINGS M5 FTT-C-TC KNURLED</td> <td>2.000</td> <td>PC</td> </tr> <tr> <td>VI1640A0</td> <td>BRASS NUT M13x1 H7 CH1</td> <td>1.000</td> <td>PC</td> </tr> <tr> <td>VI1645A0</td> <td>NICKEL BRASS NUT M13x1 H4 CH1</td> <td>1.000</td> <td>PC</td> </tr> <tr> <td>VI1655A0</td> <td>LID FULCRUM PIN D6.8 M5x0.8 H23</td> <td>2.000</td> <td>PC</td> </tr> <tr> <td>VM2145A0</td> <td>15X15 L70 SQUARE PROFILE</td> <td>2.000</td> <td>PC</td> </tr> <tr> <td>VM2576A0</td> <td>SP015 15x15 L35 SQUARE PROFILE</td> <td>2.000</td> <td>PC</td> </tr> <tr> <td>VT1389A0</td> <td>SP015 BLACK SMOOTH GLASS CERAMIC</td> <td>1.000</td> <td>PC</td> </tr> </tbody> </table>		Code	Description	Qty	UOM	0D2013B0	SP015 GRILL UPPER GLASS SUPPORT	1.000	PC	0H4183A1	SP015 GRILL FAN GUARD COUNTER BRACKET	1.000	PC	SL1171A1	SILICON ANTHRACITE S57 BARREL	0.010	ML	TB1517A0	TB1517A0	1.000	PC	VI1220A1	4,2x12 TCB SELF-TAPPIN G SCREW	9.000	PC	VI1605A0	BUSHINGS M5 FTT-C-TC KNURLED	2.000	PC	VI1640A0	BRASS NUT M13x1 H7 CH1	1.000	PC	VI1645A0	NICKEL BRASS NUT M13x1 H4 CH1	1.000	PC	VI1655A0	LID FULCRUM PIN D6.8 M5x0.8 H23	2.000	PC	VM2145A0	15X15 L70 SQUARE PROFILE	2.000	PC	VM2576A0	SP015 15x15 L35 SQUARE PROFILE	2.000	PC	VT1389A0	SP015 BLACK SMOOTH GLASS CERAMIC	1.000	PC
Code	Description	Qty	UOM																																																							
0D2013B0	SP015 GRILL UPPER GLASS SUPPORT	1.000	PC																																																							
0H4183A1	SP015 GRILL FAN GUARD COUNTER BRACKET	1.000	PC																																																							
SL1171A1	SILICON ANTHRACITE S57 BARREL	0.010	ML																																																							
TB1517A0	TB1517A0	1.000	PC																																																							
VI1220A1	4,2x12 TCB SELF-TAPPIN G SCREW	9.000	PC																																																							
VI1605A0	BUSHINGS M5 FTT-C-TC KNURLED	2.000	PC																																																							
VI1640A0	BRASS NUT M13x1 H7 CH1	1.000	PC																																																							
VI1645A0	NICKEL BRASS NUT M13x1 H4 CH1	1.000	PC																																																							
VI1655A0	LID FULCRUM PIN D6.8 M5x0.8 H23	2.000	PC																																																							
VM2145A0	15X15 L70 SQUARE PROFILE	2.000	PC																																																							
VM2576A0	SP015 15x15 L35 SQUARE PROFILE	2.000	PC																																																							
VT1389A0	SP015 BLACK SMOOTH GLASS CERAMIC	1.000	PC																																																							

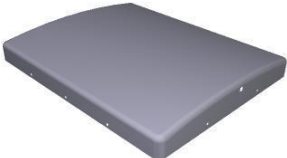
ASM2320A/0.D07 - General overview - FRONT







ASM2320A/0.D07 - General overview - REAR

COMPONENT			SPARE PART		
Code	Description	Image	Code	Description	Kit components
0D2012B	SP015 UPPER HEATING ELEMENT BOX		0D2012B0	SP015 UPPER HEATING ELEMENT BOX	
0D2013B	SP015 GRILL UPPER GLASS SUPPORT		0D2013B0	SP015 GRILL UPPER GLASS SUPPORT	
0H2517A	BRACKET SIDE SPRINGS SEAT		0H2517A0	BRACKET SIDE SPRINGS SEAT	
0H2518A	HANDLE SIDE SPRINGS SEAT		0H2518A0	HANDLE SIDE SPRINGS SEAT	
0H4815A	XP CONTACT GRILL LEFT HANDLE BRACKET		0H4815A0	XP CONTACT GRILL LEFT HANDLE BRACKET	

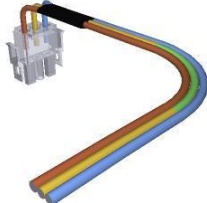
COMPONENT			SPARE PART																																						
Code	Description	Image	Code	Description	Kit components																																				
0H4816A	XP CONTACT GRILL RIGHT HANDLE BRACKET		K0H4816A	XP RIGHT HANDLE BRACKET KIT	<table border="1"> <thead> <tr> <th>Code</th> <th>Description</th> <th>Qty</th> <th>UOM</th> </tr> </thead> <tbody> <tr> <td>0H4816A0</td> <td>XP CONTACT GRILL RIGHT HANDLE BRACKET</td> <td>1.000</td> <td>PC</td> </tr> <tr> <td>V11605A0</td> <td>BUSHINGS M5 FTT-C-TC KNURLED</td> <td>1.000</td> <td>PC</td> </tr> </tbody> </table>	Code	Description	Qty	UOM	0H4816A0	XP CONTACT GRILL RIGHT HANDLE BRACKET	1.000	PC	V11605A0	BUSHINGS M5 FTT-C-TC KNURLED	1.000	PC																								
					Code	Description	Qty	UOM																																	
0H4816A0	XP CONTACT GRILL RIGHT HANDLE BRACKET	1.000	PC																																						
V11605A0	BUSHINGS M5 FTT-C-TC KNURLED	1.000	PC																																						
<table border="1"> <thead> <tr> <th>Code</th> <th>Description</th> <th>Qty</th> <th>UOM</th> </tr> </thead> <tbody> <tr> <td>RS1301A0</td> <td>RS1301A0</td> <td>1.000</td> <td>PC</td> </tr> <tr> <td>RS1305A0</td> <td>RS1305A0</td> <td>1.000</td> <td>PC</td> </tr> </tbody> </table>	Code	Description	Qty	UOM	RS1301A0	RS1301A0	1.000	PC	RS1305A0	RS1305A0	1.000	PC																													
Code	Description	Qty	UOM																																						
RS1301A0	RS1301A0	1.000	PC																																						
RS1305A0	RS1305A0	1.000	PC																																						
RS1301A	RS1301A0		KRS1301A	SP015 1400W HEATING ELEMENT KIT	<table border="1"> <thead> <tr> <th>Code</th> <th>Description</th> <th>Qty</th> <th>UOM</th> </tr> </thead> <tbody> <tr> <td>RS1301A0</td> <td>RS1301A0</td> <td>1.000</td> <td>PC</td> </tr> <tr> <td>RS1305A0</td> <td>RS1305A0</td> <td>1.000</td> <td>PC</td> </tr> </tbody> </table>	Code	Description	Qty	UOM	RS1301A0	RS1301A0	1.000	PC	RS1305A0	RS1305A0	1.000	PC																								
Code	Description	Qty	UOM																																						
RS1301A0	RS1301A0	1.000	PC																																						
RS1305A0	RS1305A0	1.000	PC																																						
GN1095A	Ø14 - L=30 NEOPRENE SLEEVE		KGN1095A	Ø14 - L=30 NEOPRENE SLEEVE KIT	<table border="1"> <thead> <tr> <th>Code</th> <th>Description</th> <th>Qty</th> <th>UOM</th> </tr> </thead> <tbody> <tr> <td>GN1095A0</td> <td>Ø14 - L=30 NEOPRENE SLEEVE</td> <td>4.000</td> <td>PC</td> </tr> </tbody> </table>	Code	Description	Qty	UOM	GN1095A0	Ø14 - L=30 NEOPRENE SLEEVE	4.000	PC																												
Code	Description	Qty	UOM																																						
GN1095A0	Ø14 - L=30 NEOPRENE SLEEVE	4.000	PC																																						
GN1322A	EXT Ø 27 INT Ø 10 GASKET		KML1020A	XP-SP SPIDO ML1000A SPRINGS KIT	<table border="1"> <thead> <tr> <th>Code</th> <th>Description</th> <th>Qty</th> <th>UOM</th> </tr> </thead> <tbody> <tr> <td>0H2517A0</td> <td>BRACKET SIDE SPRINGS SEAT</td> <td>1.000</td> <td>PC</td> </tr> <tr> <td>0H2518A0</td> <td>HANDLE SIDE SPRINGS SEA</td> <td>1.000</td> <td>PC</td> </tr> <tr> <td>GN1322A0</td> <td>EXT Ø 27 INT Ø 10 GASKET</td> <td>2.000</td> <td>PC</td> </tr> <tr> <td>ML1000A1</td> <td>De24.4 H44 12 TURNS TORSION SPRING</td> <td>2.000</td> <td>PC</td> </tr> <tr> <td>V11047A0</td> <td>SCREW M5x10 TSP+ ZINC.TO THICKNE.12</td> <td>2.000</td> <td>PC</td> </tr> <tr> <td>V11093A0</td> <td>M10X30 TCEI 12.9 UNI5931 SCREW</td> <td>1.000</td> <td>PC</td> </tr> <tr> <td>V11096A0</td> <td>M10x110 TCEI SCREW</td> <td>1.000</td> <td>PC</td> </tr> <tr> <td>V11303A0</td> <td>M10 H6 ZN LOW NUT</td> <td>4.000</td> <td>PC</td> </tr> </tbody> </table>	Code	Description	Qty	UOM	0H2517A0	BRACKET SIDE SPRINGS SEAT	1.000	PC	0H2518A0	HANDLE SIDE SPRINGS SEA	1.000	PC	GN1322A0	EXT Ø 27 INT Ø 10 GASKET	2.000	PC	ML1000A1	De24.4 H44 12 TURNS TORSION SPRING	2.000	PC	V11047A0	SCREW M5x10 TSP+ ZINC.TO THICKNE.12	2.000	PC	V11093A0	M10X30 TCEI 12.9 UNI5931 SCREW	1.000	PC	V11096A0	M10x110 TCEI SCREW	1.000	PC	V11303A0	M10 H6 ZN LOW NUT	4.000	PC
Code	Description	Qty	UOM																																						
0H2517A0	BRACKET SIDE SPRINGS SEAT	1.000	PC																																						
0H2518A0	HANDLE SIDE SPRINGS SEA	1.000	PC																																						
GN1322A0	EXT Ø 27 INT Ø 10 GASKET	2.000	PC																																						
ML1000A1	De24.4 H44 12 TURNS TORSION SPRING	2.000	PC																																						
V11047A0	SCREW M5x10 TSP+ ZINC.TO THICKNE.12	2.000	PC																																						
V11093A0	M10X30 TCEI 12.9 UNI5931 SCREW	1.000	PC																																						
V11096A0	M10x110 TCEI SCREW	1.000	PC																																						
V11303A0	M10 H6 ZN LOW NUT	4.000	PC																																						

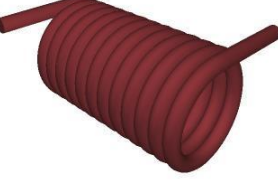
COMPONENT			SPARE PART																																																											
Code	Description	Image	Code	Description	Kit components																																																									
GN1322A	EXT Ø 27 INT Ø 10 GASKET		KML1020A	XP-SP SPIDO ML1000A SPRINGS KIT	<table border="1"> <thead> <tr> <th>Code</th> <th>Description</th> <th>Qty</th> <th>UOM</th> </tr> </thead> <tbody> <tr> <td>VI1451A0</td> <td>10X20X0.5 BRASS NICKEL FLAT WASHER</td> <td>1.000</td> <td>PC</td> </tr> <tr> <td>VI1528A0</td> <td>10X30X2 ZN FLAT WASHER</td> <td>2.000</td> <td>PC</td> </tr> <tr> <td>VM1512A0</td> <td>SPIDO.COOK SPRING FIXING RING</td> <td>2.000</td> <td>PC</td> </tr> </tbody> </table>	Code	Description	Qty	UOM	VI1451A0	10X20X0.5 BRASS NICKEL FLAT WASHER	1.000	PC	VI1528A0	10X30X2 ZN FLAT WASHER	2.000	PC	VM1512A0	SPIDO.COOK SPRING FIXING RING	2.000	PC																																									
			Code	Description	Qty	UOM																																																								
VI1451A0	10X20X0.5 BRASS NICKEL FLAT WASHER	1.000	PC																																																											
VI1528A0	10X30X2 ZN FLAT WASHER	2.000	PC																																																											
VM1512A0	SPIDO.COOK SPRING FIXING RING	2.000	PC																																																											
KML0039A	XP SPRING RETROFIT KIT	<table border="1"> <thead> <tr> <th>Code</th> <th>Description</th> <th>Qty</th> <th>UOM</th> </tr> </thead> <tbody> <tr> <td>0H0159A0</td> <td>CONTACT GRILL HANDLE SUPPORT DOUBLE</td> <td>1.000</td> <td>PC</td> </tr> <tr> <td>0H2517A0</td> <td>BRACKET SIDE SPRINGS SEAT</td> <td>1.000</td> <td>PC</td> </tr> <tr> <td>0H2518A0</td> <td>HANDLE SIDE SPRINGS SEA</td> <td>1.000</td> <td>PC</td> </tr> <tr> <td>0H4816A0</td> <td>XP CONTACT GRILL RIGHT HANDLE BRACKET</td> <td>1.000</td> <td>PC</td> </tr> <tr> <td>GN1322A0</td> <td>EXT Ø 27 INT Ø 10 GASKET</td> <td>2.000</td> <td>PC</td> </tr> <tr> <td>ML1000A1</td> <td>De24.4 H44 12 TURNS TORSION SPRING</td> <td>1.000</td> <td>PC</td> </tr> <tr> <td>VI1047A0</td> <td>SCREW M5x10 TSP+ ZINC.TO THICKNE.12</td> <td>1.000</td> <td>PC</td> </tr> <tr> <td>VI1093A0</td> <td>M10X30 TCEI 12.9 UNI5931 SCREW</td> <td>1.000</td> <td>PC</td> </tr> <tr> <td>VI1096A0</td> <td>M10x110 TCEI SCREW</td> <td>1.000</td> <td>PC</td> </tr> <tr> <td>VI1303A0</td> <td>M10 H6 ZN LOW NUT</td> <td>4.000</td> <td>PC</td> </tr> <tr> <td>VI1451A0</td> <td>10X20X0.5 BRASS NICKEL FLAT WASHER</td> <td>1.000</td> <td>PC</td> </tr> <tr> <td>VI1528A0</td> <td>10X30X2 ZN FLAT WASHER</td> <td>2.000</td> <td>PC</td> </tr> <tr> <td>VI1605A0</td> <td>BUSHINGS M5 FTT-C-TC KNURLED</td> <td>1.000</td> <td>PC</td> </tr> <tr> <td>VM1512A0</td> <td>SPIDO.COOK SPRING FIXING RING</td> <td>1.000</td> <td>PC</td> </tr> </tbody> </table>	Code	Description	Qty	UOM	0H0159A0	CONTACT GRILL HANDLE SUPPORT DOUBLE	1.000	PC	0H2517A0	BRACKET SIDE SPRINGS SEAT	1.000	PC	0H2518A0	HANDLE SIDE SPRINGS SEA	1.000	PC	0H4816A0	XP CONTACT GRILL RIGHT HANDLE BRACKET	1.000	PC	GN1322A0	EXT Ø 27 INT Ø 10 GASKET	2.000	PC	ML1000A1	De24.4 H44 12 TURNS TORSION SPRING	1.000	PC	VI1047A0	SCREW M5x10 TSP+ ZINC.TO THICKNE.12	1.000	PC	VI1093A0	M10X30 TCEI 12.9 UNI5931 SCREW	1.000	PC	VI1096A0	M10x110 TCEI SCREW	1.000	PC	VI1303A0	M10 H6 ZN LOW NUT	4.000	PC	VI1451A0	10X20X0.5 BRASS NICKEL FLAT WASHER	1.000	PC	VI1528A0	10X30X2 ZN FLAT WASHER	2.000	PC	VI1605A0	BUSHINGS M5 FTT-C-TC KNURLED	1.000	PC	VM1512A0	SPIDO.COOK SPRING FIXING RING	1.000	PC
Code	Description	Qty	UOM																																																											
0H0159A0	CONTACT GRILL HANDLE SUPPORT DOUBLE	1.000	PC																																																											
0H2517A0	BRACKET SIDE SPRINGS SEAT	1.000	PC																																																											
0H2518A0	HANDLE SIDE SPRINGS SEA	1.000	PC																																																											
0H4816A0	XP CONTACT GRILL RIGHT HANDLE BRACKET	1.000	PC																																																											
GN1322A0	EXT Ø 27 INT Ø 10 GASKET	2.000	PC																																																											
ML1000A1	De24.4 H44 12 TURNS TORSION SPRING	1.000	PC																																																											
VI1047A0	SCREW M5x10 TSP+ ZINC.TO THICKNE.12	1.000	PC																																																											
VI1093A0	M10X30 TCEI 12.9 UNI5931 SCREW	1.000	PC																																																											
VI1096A0	M10x110 TCEI SCREW	1.000	PC																																																											
VI1303A0	M10 H6 ZN LOW NUT	4.000	PC																																																											
VI1451A0	10X20X0.5 BRASS NICKEL FLAT WASHER	1.000	PC																																																											
VI1528A0	10X30X2 ZN FLAT WASHER	2.000	PC																																																											
VI1605A0	BUSHINGS M5 FTT-C-TC KNURLED	1.000	PC																																																											
VM1512A0	SPIDO.COOK SPRING FIXING RING	1.000	PC																																																											

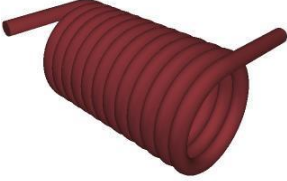
COMPONENT			SPARE PART																						
Code	Description	Image	Code	Description	Kit components																				
GN1322A	EXT Ø 27 INT Ø 10 GASKET		KG1322A	GASKET KIT DE27 DI10 SP2	<table border="1"> <thead> <tr> <th>Code</th> <th>Description</th> <th>Qty</th> <th>UOM</th> </tr> </thead> <tbody> <tr> <td>GN1322A0</td> <td>EXT Ø 27 INT Ø 10 GASKET</td> <td>2.000</td> <td>PC</td> </tr> </tbody> </table>	Code	Description	Qty	UOM	GN1322A0	EXT Ø 27 INT Ø 10 GASKET	2.000	PC												
Code	Description	Qty	UOM																						
GN1322A0	EXT Ø 27 INT Ø 10 GASKET	2.000	PC																						
IE1530A	UPPER HEATING ELEMENTS KIT SERIE XAP		KIE1530A	XAP SAP UPPER HEATING ELEMENT KIT	<table border="1"> <thead> <tr> <th>Code</th> <th>Description</th> <th>Qty</th> <th>UOM</th> </tr> </thead> <tbody> <tr> <td>GN1095A0</td> <td>Ø14 - L=30 NEOPRENE SLEEVE</td> <td>1.000</td> <td>PC</td> </tr> <tr> <td>IE1530A0</td> <td>UPPER HEATING ELEMENTS KIT SERIE XAP</td> <td>1.000</td> <td>PC</td> </tr> </tbody> </table>	Code	Description	Qty	UOM	GN1095A0	Ø14 - L=30 NEOPRENE SLEEVE	1.000	PC	IE1530A0	UPPER HEATING ELEMENTS KIT SERIE XAP	1.000	PC								
Code	Description	Qty	UOM																						
GN1095A0	Ø14 - L=30 NEOPRENE SLEEVE	1.000	PC																						
IE1530A0	UPPER HEATING ELEMENTS KIT SERIE XAP	1.000	PC																						
MG1040A	CLAMPSHELL GRILL UPPER HANDLE		KMG1040A	CLAMPSHELL GRILL HANDLE KIT	<table border="1"> <thead> <tr> <th>Code</th> <th>Description</th> <th>Qty</th> <th>UOM</th> </tr> </thead> <tbody> <tr> <td>MG1040A1</td> <td>CLAMPSHELL GRILL UPPER HANDLE</td> <td>1.000</td> <td>PC</td> </tr> <tr> <td>MG1041A0</td> <td>XP SERIES LOWER HANDLE</td> <td>1.000</td> <td>PC</td> </tr> <tr> <td>VI1955A0</td> <td>ST STEEL CROSS SCREW 4x20</td> <td>2.000</td> <td>PC</td> </tr> </tbody> </table>	Code	Description	Qty	UOM	MG1040A1	CLAMPSHELL GRILL UPPER HANDLE	1.000	PC	MG1041A0	XP SERIES LOWER HANDLE	1.000	PC	VI1955A0	ST STEEL CROSS SCREW 4x20	2.000	PC				
Code	Description	Qty	UOM																						
MG1040A1	CLAMPSHELL GRILL UPPER HANDLE	1.000	PC																						
MG1041A0	XP SERIES LOWER HANDLE	1.000	PC																						
VI1955A0	ST STEEL CROSS SCREW 4x20	2.000	PC																						
MG1041A	XP SERIES LOWER HANDLE		KMG1040A	CLAMPSHELL GRILL HANDLE KIT	<table border="1"> <thead> <tr> <th>Code</th> <th>Description</th> <th>Qty</th> <th>UOM</th> </tr> </thead> <tbody> <tr> <td>MG1040A1</td> <td>CLAMPSHELL GRILL UPPER HANDLE</td> <td>1.000</td> <td>PC</td> </tr> <tr> <td>MG1041A0</td> <td>XP SERIES LOWER HANDLE</td> <td>1.000</td> <td>PC</td> </tr> <tr> <td>VI1955A0</td> <td>ST STEEL CROSS SCREW 4x20</td> <td>2.000</td> <td>PC</td> </tr> </tbody> </table>	Code	Description	Qty	UOM	MG1040A1	CLAMPSHELL GRILL UPPER HANDLE	1.000	PC	MG1041A0	XP SERIES LOWER HANDLE	1.000	PC	VI1955A0	ST STEEL CROSS SCREW 4x20	2.000	PC				
Code	Description	Qty	UOM																						
MG1040A1	CLAMPSHELL GRILL UPPER HANDLE	1.000	PC																						
MG1041A0	XP SERIES LOWER HANDLE	1.000	PC																						
VI1955A0	ST STEEL CROSS SCREW 4x20	2.000	PC																						
ML1000A	De24.4 H44 12 TURNS TORSION SPRING		KML1020A	XP-SP SPIDO ML1000A SPRINGS KIT	<table border="1"> <thead> <tr> <th>Code</th> <th>Description</th> <th>Qty</th> <th>UOM</th> </tr> </thead> <tbody> <tr> <td>0H2517A0</td> <td>BRACKET SIDE SPRINGS SEAT</td> <td>1.000</td> <td>PC</td> </tr> <tr> <td>0H2518A0</td> <td>HANDLE SIDE SPRINGS SEA</td> <td>1.000</td> <td>PC</td> </tr> <tr> <td>GN1322A0</td> <td>EXT Ø 27 INT Ø 10 GASKET</td> <td>2.000</td> <td>PC</td> </tr> <tr> <td>ML1000A1</td> <td>De24.4 H44 12 TURNS TORSION SPRING</td> <td>2.000</td> <td>PC</td> </tr> </tbody> </table>	Code	Description	Qty	UOM	0H2517A0	BRACKET SIDE SPRINGS SEAT	1.000	PC	0H2518A0	HANDLE SIDE SPRINGS SEA	1.000	PC	GN1322A0	EXT Ø 27 INT Ø 10 GASKET	2.000	PC	ML1000A1	De24.4 H44 12 TURNS TORSION SPRING	2.000	PC
Code	Description	Qty	UOM																						
0H2517A0	BRACKET SIDE SPRINGS SEAT	1.000	PC																						
0H2518A0	HANDLE SIDE SPRINGS SEA	1.000	PC																						
GN1322A0	EXT Ø 27 INT Ø 10 GASKET	2.000	PC																						
ML1000A1	De24.4 H44 12 TURNS TORSION SPRING	2.000	PC																						

COMPONENT			SPARE PART																																																		
Code	Description	Image	Code	Description	Kit components																																																
ML1000A	De24.4 H44 12 TURNS TORSION SPRING		KML1020A	XP-SP SPIDO ML1000A SPRINGS KIT	<table border="1"> <thead> <tr> <th>Code</th> <th>Description</th> <th>Qty</th> <th>UOM</th> </tr> </thead> <tbody> <tr> <td>VI1047A0</td> <td>SCREW M5x10 TSP+ ZINC.TO THICKNE.12</td> <td>2.000</td> <td>PC</td> </tr> <tr> <td>VI1093A0</td> <td>M10X30 TCEI 12.9 UNI5931 SCREW</td> <td>1.000</td> <td>PC</td> </tr> <tr> <td>VI1096A0</td> <td>M10x110 TCEI SCREW</td> <td>1.000</td> <td>PC</td> </tr> <tr> <td>VI1303A0</td> <td>M10 H6 ZN LOW NUT</td> <td>4.000</td> <td>PC</td> </tr> <tr> <td>VI1451A0</td> <td>10X20X0.5 BRASS NICKEL FLAT WASHER</td> <td>1.000</td> <td>PC</td> </tr> <tr> <td>VI1528A0</td> <td>10X30X2 ZN FLAT WASHER</td> <td>2.000</td> <td>PC</td> </tr> <tr> <td>VM1512A0</td> <td>SPIDO.COOK SPRING FIXING RING</td> <td>2.000</td> <td>PC</td> </tr> </tbody> </table>	Code	Description	Qty	UOM	VI1047A0	SCREW M5x10 TSP+ ZINC.TO THICKNE.12	2.000	PC	VI1093A0	M10X30 TCEI 12.9 UNI5931 SCREW	1.000	PC	VI1096A0	M10x110 TCEI SCREW	1.000	PC	VI1303A0	M10 H6 ZN LOW NUT	4.000	PC	VI1451A0	10X20X0.5 BRASS NICKEL FLAT WASHER	1.000	PC	VI1528A0	10X30X2 ZN FLAT WASHER	2.000	PC	VM1512A0	SPIDO.COOK SPRING FIXING RING	2.000	PC																
Code	Description	Qty	UOM																																																		
VI1047A0	SCREW M5x10 TSP+ ZINC.TO THICKNE.12	2.000	PC																																																		
VI1093A0	M10X30 TCEI 12.9 UNI5931 SCREW	1.000	PC																																																		
VI1096A0	M10x110 TCEI SCREW	1.000	PC																																																		
VI1303A0	M10 H6 ZN LOW NUT	4.000	PC																																																		
VI1451A0	10X20X0.5 BRASS NICKEL FLAT WASHER	1.000	PC																																																		
VI1528A0	10X30X2 ZN FLAT WASHER	2.000	PC																																																		
VM1512A0	SPIDO.COOK SPRING FIXING RING	2.000	PC																																																		
TB1517A	TB1517A0		KTB1517A	STAINLESS STEEL TUBE KIT D-EST13 SP015	<table border="1"> <thead> <tr> <th>Code</th> <th>Description</th> <th>Qty</th> <th>UOM</th> </tr> </thead> <tbody> <tr> <td>CE1155A0</td> <td>6,3x0,81 - 2.5 ALPACA FEMALE FASTON</td> <td>1.000</td> <td>PC</td> </tr> <tr> <td>CE1330A0</td> <td>3 WAYS MALE INAR-LOCK CONNECTOR</td> <td>1.000</td> <td>PC</td> </tr> <tr> <td>CE1350A0</td> <td>MALE INAR-LOCK END CONNECTOR</td> <td>3.000</td> <td>PC</td> </tr> <tr> <td>CE1455A0</td> <td>TIP END FITTING</td> <td>2.000</td> <td>PC</td> </tr> <tr> <td>CE1535A0</td> <td>YELLOW/GRE EN UNIP AWG18 ST.3135 WIRE</td> <td>0.280</td> <td>M</td> </tr> <tr> <td>CE1625A1</td> <td>WHITE UNIP AWG16 ST.3135 WIRE</td> <td>0.350</td> <td>M</td> </tr> <tr> <td>CE1630A1</td> <td>BALCK UNIP AWG16 ST.3135 WIRE</td> <td>0.350</td> <td>M</td> </tr> <tr> <td>GN1095A0</td> <td>Ø14 - L=30 NEOPRENE SLEEVE</td> <td>2.000</td> <td>PC</td> </tr> <tr> <td>TB1505A0</td> <td>STAINLESS STEEL BENDEED TUBE D13</td> <td>1.000</td> <td>PC</td> </tr> <tr> <td>VI1640A0</td> <td>BRASS NUT M13x1 H7 CH1</td> <td>1.000</td> <td>PC</td> </tr> <tr> <td>VI1645A0</td> <td>NICKEL BRASS NUT M13x1 H4 CH1</td> <td>1.000</td> <td>PC</td> </tr> </tbody> </table>	Code	Description	Qty	UOM	CE1155A0	6,3x0,81 - 2.5 ALPACA FEMALE FASTON	1.000	PC	CE1330A0	3 WAYS MALE INAR-LOCK CONNECTOR	1.000	PC	CE1350A0	MALE INAR-LOCK END CONNECTOR	3.000	PC	CE1455A0	TIP END FITTING	2.000	PC	CE1535A0	YELLOW/GRE EN UNIP AWG18 ST.3135 WIRE	0.280	M	CE1625A1	WHITE UNIP AWG16 ST.3135 WIRE	0.350	M	CE1630A1	BALCK UNIP AWG16 ST.3135 WIRE	0.350	M	GN1095A0	Ø14 - L=30 NEOPRENE SLEEVE	2.000	PC	TB1505A0	STAINLESS STEEL BENDEED TUBE D13	1.000	PC	VI1640A0	BRASS NUT M13x1 H7 CH1	1.000	PC	VI1645A0	NICKEL BRASS NUT M13x1 H4 CH1	1.000	PC
Code	Description	Qty	UOM																																																		
CE1155A0	6,3x0,81 - 2.5 ALPACA FEMALE FASTON	1.000	PC																																																		
CE1330A0	3 WAYS MALE INAR-LOCK CONNECTOR	1.000	PC																																																		
CE1350A0	MALE INAR-LOCK END CONNECTOR	3.000	PC																																																		
CE1455A0	TIP END FITTING	2.000	PC																																																		
CE1535A0	YELLOW/GRE EN UNIP AWG18 ST.3135 WIRE	0.280	M																																																		
CE1625A1	WHITE UNIP AWG16 ST.3135 WIRE	0.350	M																																																		
CE1630A1	BALCK UNIP AWG16 ST.3135 WIRE	0.350	M																																																		
GN1095A0	Ø14 - L=30 NEOPRENE SLEEVE	2.000	PC																																																		
TB1505A0	STAINLESS STEEL BENDEED TUBE D13	1.000	PC																																																		
VI1640A0	BRASS NUT M13x1 H7 CH1	1.000	PC																																																		
VI1645A0	NICKEL BRASS NUT M13x1 H4 CH1	1.000	PC																																																		

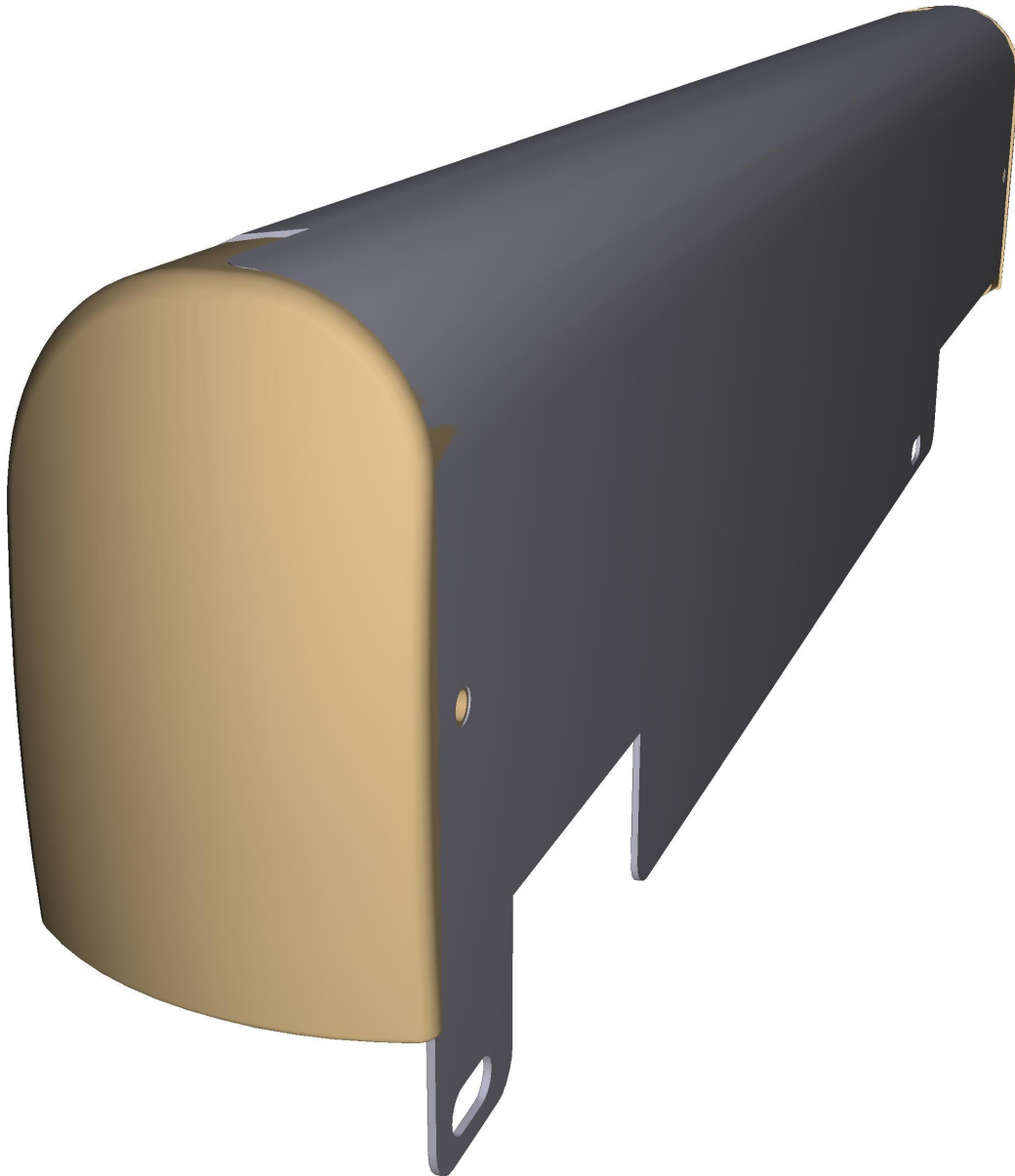

COMPONENT			SPARE PART																														
Code	Description	Image	Code	Description	Kit components																												
TB1835A	SPIDOCOOK SP015 HANDLE TUBE		KTB1835A	SP015 GRILL HANDLE TUBE	<table border="1"> <thead> <tr> <th>Code</th> <th>Description</th> <th>Qty</th> <th>UOM</th> </tr> </thead> <tbody> <tr> <td>TB1835A0</td> <td>SPIDOCOOK SP015 HANDLE TUBE</td> <td>1.000</td> <td>PC</td> </tr> </tbody> </table>	Code	Description	Qty	UOM	TB1835A0	SPIDOCOOK SP015 HANDLE TUBE	1.000	PC																				
Code	Description	Qty	UOM																														
TB1835A0	SPIDOCOOK SP015 HANDLE TUBE	1.000	PC																														
VI1096A	M10x110 TCEI SCRE		KVI1096A	M10x110 SCREW 10 PCS. KIT	<table border="1"> <thead> <tr> <th>Code</th> <th>Description</th> <th>Qty</th> <th>UOM</th> </tr> </thead> <tbody> <tr> <td>VI1096A0</td> <td>M10x110 TCEI SCREW</td> <td>10.000</td> <td>PC</td> </tr> </tbody> </table>	Code	Description	Qty	UOM	VI1096A0	M10x110 TCEI SCREW	10.000	PC																				
Code	Description	Qty	UOM																														
VI1096A0	M10x110 TCEI SCREW	10.000	PC																														
VI1655A	LID FULCRUM PIN D6.8 M5x0.8 H23		KVI1655A	LID FULCRUM PIN 4 PCS. KIT	<table border="1"> <thead> <tr> <th>Code</th> <th>Description</th> <th>Qty</th> <th>UOM</th> </tr> </thead> <tbody> <tr> <td>VI1655A0</td> <td>LID FULCRUM PIN D6.8 M5x0.8 H23</td> <td>4.000</td> <td>PC</td> </tr> </tbody> </table>	Code	Description	Qty	UOM	VI1655A0	LID FULCRUM PIN D6.8 M5x0.8 H23	4.000	PC																				
Code	Description	Qty	UOM																														
VI1655A0	LID FULCRUM PIN D6.8 M5x0.8 H23	4.000	PC																														
VM1512A	SPIDO.COOK SPRING FIXING RIN		VM1512A0	SPIDO.COOK SPRING FIXING RIN																													
VT1127A	SP015 BLACK RIBBED GLASS		KVT1127B	SP015 UPPER BLACK RIBBED GLASS KIT	<table border="1"> <thead> <tr> <th>Code</th> <th>Description</th> <th>Qty</th> <th>UOM</th> </tr> </thead> <tbody> <tr> <td>0D2013B0</td> <td>SP015 GRILL UPPER GLASS SUPPORT</td> <td>1.000</td> <td>PC</td> </tr> <tr> <td>SL1171A1</td> <td>SILICON ANTHRACITE S57 BARREL</td> <td>0.010</td> <td>ML</td> </tr> <tr> <td>VI1220A1</td> <td>4,2x12 TCB SELF-TAPPIN G SCREW</td> <td>9.000</td> <td>PC</td> </tr> <tr> <td>VM2145A0</td> <td>15X15 L70 SQUARE PROFILE</td> <td>2.000</td> <td>PC</td> </tr> <tr> <td>VM2576A0</td> <td>SP015 15x15 L35 SQUARE PROFILE</td> <td>2.000</td> <td>PC</td> </tr> <tr> <td>VT1127A0</td> <td>SP015 BLACK RIBBED GLAS</td> <td>1.000</td> <td>PC</td> </tr> </tbody> </table>	Code	Description	Qty	UOM	0D2013B0	SP015 GRILL UPPER GLASS SUPPORT	1.000	PC	SL1171A1	SILICON ANTHRACITE S57 BARREL	0.010	ML	VI1220A1	4,2x12 TCB SELF-TAPPIN G SCREW	9.000	PC	VM2145A0	15X15 L70 SQUARE PROFILE	2.000	PC	VM2576A0	SP015 15x15 L35 SQUARE PROFILE	2.000	PC	VT1127A0	SP015 BLACK RIBBED GLAS	1.000	PC
Code	Description	Qty	UOM																														
0D2013B0	SP015 GRILL UPPER GLASS SUPPORT	1.000	PC																														
SL1171A1	SILICON ANTHRACITE S57 BARREL	0.010	ML																														
VI1220A1	4,2x12 TCB SELF-TAPPIN G SCREW	9.000	PC																														
VM2145A0	15X15 L70 SQUARE PROFILE	2.000	PC																														
VM2576A0	SP015 15x15 L35 SQUARE PROFILE	2.000	PC																														
VT1127A0	SP015 BLACK RIBBED GLAS	1.000	PC																														

ASM2330A/0.D00 - General overview - FRONT

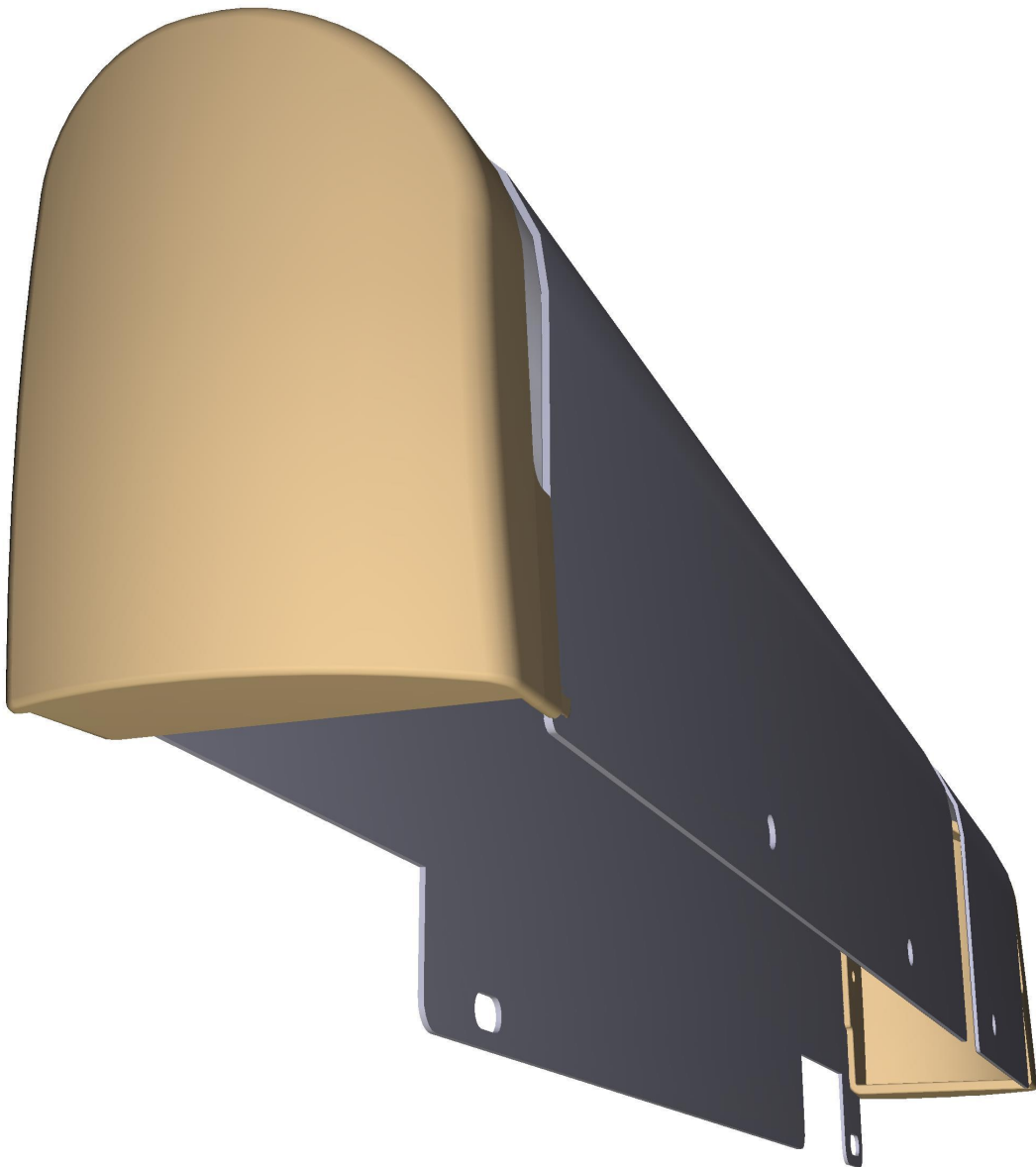

ASM2330A/0.D00 - General overview - REAR

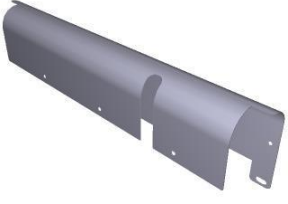

COMPONENT			SPARE PART										
Code	Description	Image	Code	Description	Kit components								
0D1987A	SP015 MECHANISM COVER PLATE		0D1987A0	SP015 MECHANISM COVER PLATE									
VM1550A	SP GRILL MECHANISM COVER RIGHT CAP		KVM1550A	CONT GRILL MECHANISM COVER RIGHT CAP KIT	<table border="1"> <thead> <tr> <th>Code</th> <th>Description</th> <th>Qty</th> <th>UOM</th> </tr> </thead> <tbody> <tr> <td>VM1550A1</td> <td>SP GRILL MECHANISM COVER RIGHT CAP</td> <td>1.000</td> <td>PC</td> </tr> </tbody> </table>	Code	Description	Qty	UOM	VM1550A1	SP GRILL MECHANISM COVER RIGHT CAP	1.000	PC
Code	Description	Qty	UOM										
VM1550A1	SP GRILL MECHANISM COVER RIGHT CAP	1.000	PC										
VM1551A	CONTACT GRILL LEFT MECHANISM COVER CAP		KVM1551A	SP GRILL MECHAN.COVER LEFT CAP KIT	<table border="1"> <thead> <tr> <th>Code</th> <th>Description</th> <th>Qty</th> <th>UOM</th> </tr> </thead> <tbody> <tr> <td>VM1551A1</td> <td>CONTACT GRILL LEFT MECHANISM COVER CAP</td> <td>1.000</td> <td>PC</td> </tr> </tbody> </table>	Code	Description	Qty	UOM	VM1551A1	CONTACT GRILL LEFT MECHANISM COVER CAP	1.000	PC
Code	Description	Qty	UOM										
VM1551A1	CONTACT GRILL LEFT MECHANISM COVER CAP	1.000	PC										