

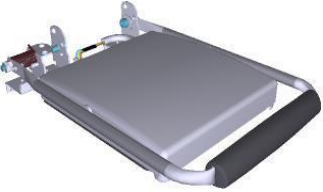





Assembly code	Assembly description	Assembly image
ASM0090A/0.D00	General overview	
ASM0091B/0.D00	General overview	
ASM0095A/0.D00	General overview	

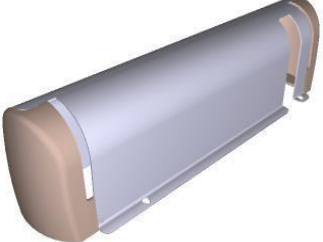
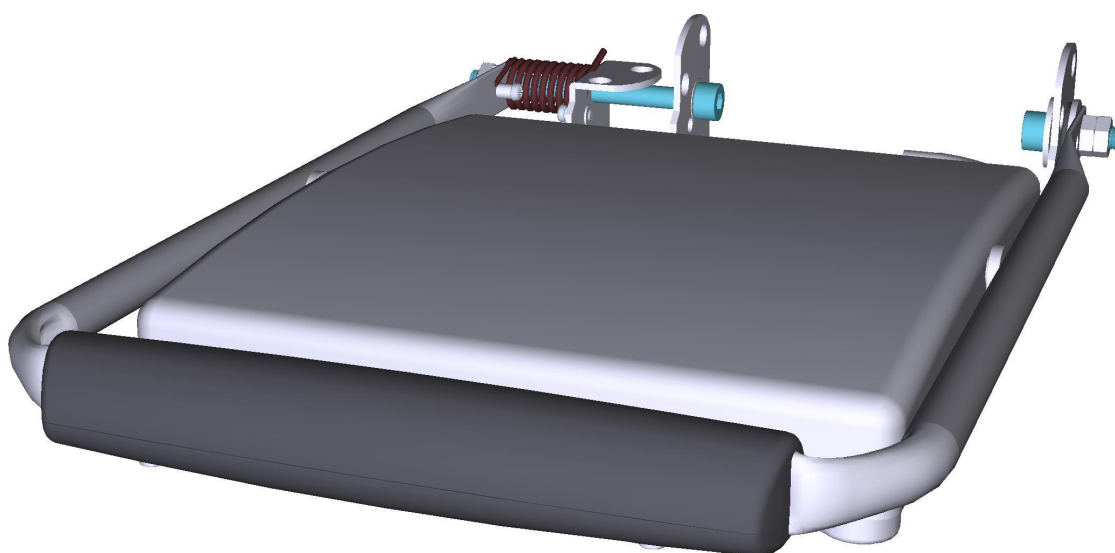
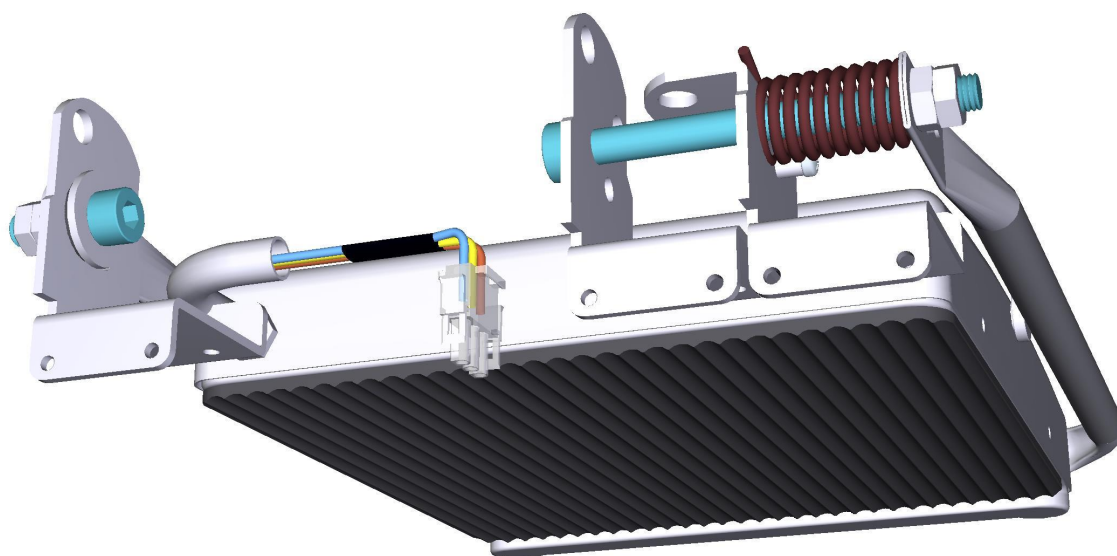

ASM0090A/0.D00 - General overview - FRONT

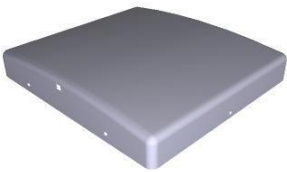



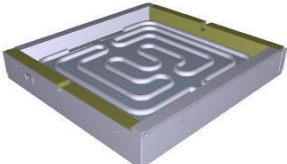

ASM0090A/0.D00 - General overview - REAR







COMPONENT			SPARE PART																		
Code	Description	Image	Code	Description	Kit components																
0D2010A	UPPER CASE HEATING ELEMENT XP		0D2010A0	UPPER CASE HEATING ELEMENT XP																	
0D2011A	XP UPPER GLASS FRAME		KVT1225A	Upper Black Smooth Single Glass CER. Kit	<table border="1"> <thead> <tr> <th>Code</th> <th>Description</th> <th>Qty</th> <th>UOM</th> </tr> </thead> <tbody> <tr> <td>0D2011A1</td> <td>XP UPPER GLASS FRAME</td> <td>1.000</td> <td>PC</td> </tr> <tr> <td>SL1171A1</td> <td>SILICON ANTHRACITE S57 BARREL</td> <td>0.010</td> <td>ML</td> </tr> <tr> <td>VT1225A0</td> <td>250X250x4 SMOOTH BLACK GLASSCERAM IC</td> <td>1.000</td> <td>PC</td> </tr> </tbody> </table>	Code	Description	Qty	UOM	0D2011A1	XP UPPER GLASS FRAME	1.000	PC	SL1171A1	SILICON ANTHRACITE S57 BARREL	0.010	ML	VT1225A0	250X250x4 SMOOTH BLACK GLASSCERAM IC	1.000	PC
Code	Description	Qty	UOM																		
0D2011A1	XP UPPER GLASS FRAME	1.000	PC																		
SL1171A1	SILICON ANTHRACITE S57 BARREL	0.010	ML																		
VT1225A0	250X250x4 SMOOTH BLACK GLASSCERAM IC	1.000	PC																		
0H4815A	XP CONTACT GRILL LEFT HANDLE BRACKET		0H4815A0	XP CONTACT GRILL LEFT HANDLE BRACKET																	
0H4816A	XP CONTACT GRILL RIGHT HANDLE BRACKET		K0H4816A	XP RIGHT HANDLE BRACKET KIT	<table border="1"> <thead> <tr> <th>Code</th> <th>Description</th> <th>Qty</th> <th>UOM</th> </tr> </thead> <tbody> <tr> <td>0H4816A0</td> <td>XP CONTACT GRILL RIGHT HANDLE BRACKET</td> <td>1.000</td> <td>PC</td> </tr> <tr> <td>VI1605A0</td> <td>BUSHINGS M5 FTT-C-TC KNURLED</td> <td>1.000</td> <td>PC</td> </tr> </tbody> </table>	Code	Description	Qty	UOM	0H4816A0	XP CONTACT GRILL RIGHT HANDLE BRACKET	1.000	PC	VI1605A0	BUSHINGS M5 FTT-C-TC KNURLED	1.000	PC				
Code	Description	Qty	UOM																		
0H4816A0	XP CONTACT GRILL RIGHT HANDLE BRACKET	1.000	PC																		
VI1605A0	BUSHINGS M5 FTT-C-TC KNURLED	1.000	PC																		
RS1258A	750W 230V GLASS CERAMIC HEATING ELEMENT		KRS1258A	750W 230V GLASS CER.HEATING EL.KI	<table border="1"> <thead> <tr> <th>Code</th> <th>Description</th> <th>Qty</th> <th>UOM</th> </tr> </thead> <tbody> <tr> <td>RS1258A0</td> <td>750W 230V GLASS CERAMIC HEATING ELEMENT</td> <td>1.000</td> <td>PC</td> </tr> <tr> <td>RS1259A0</td> <td>XP BULB HOLDER PLATE L224 7.5x0.4</td> <td>1.000</td> <td>PC</td> </tr> </tbody> </table>	Code	Description	Qty	UOM	RS1258A0	750W 230V GLASS CERAMIC HEATING ELEMENT	1.000	PC	RS1259A0	XP BULB HOLDER PLATE L224 7.5x0.4	1.000	PC				
Code	Description	Qty	UOM																		
RS1258A0	750W 230V GLASS CERAMIC HEATING ELEMENT	1.000	PC																		
RS1259A0	XP BULB HOLDER PLATE L224 7.5x0.4	1.000	PC																		

COMPONENT			SPARE PART																																																		
Code	Description	Image	Code	Description	Kit components																																																
RS1259A	XP BULB HOLDER PLATE L224 7.5x0.4		KRS1258A	750W 230V GLASS CER.HEATING EL.KI	<table border="1"> <thead> <tr> <th>Code</th> <th>Description</th> <th>Qty</th> <th>UOM</th> </tr> </thead> <tbody> <tr> <td>RS1258A0</td> <td>750W 230V GLASS CERAMIC HEATING ELEMENT</td> <td>1.000</td> <td>PC</td> </tr> <tr> <td>RS1259A0</td> <td>XP BULB HOLDER PLATE L224 7.5x0.4</td> <td>1.000</td> <td>PC</td> </tr> </tbody> </table>	Code	Description	Qty	UOM	RS1258A0	750W 230V GLASS CERAMIC HEATING ELEMENT	1.000	PC	RS1259A0	XP BULB HOLDER PLATE L224 7.5x0.4	1.000	PC																																				
			Code	Description	Qty	UOM																																															
RS1258A0	750W 230V GLASS CERAMIC HEATING ELEMENT	1.000	PC																																																		
RS1259A0	XP BULB HOLDER PLATE L224 7.5x0.4	1.000	PC																																																		
KRS1235A	500W 230V GLASS CER. HEATING EL.KI	<table border="1"> <thead> <tr> <th>Code</th> <th>Description</th> <th>Qty</th> <th>UOM</th> </tr> </thead> <tbody> <tr> <td>RS1235A1</td> <td>500W 230V GLASS CERAMIC ELEMENT</td> <td>1.000</td> <td>PC</td> </tr> <tr> <td>RS1259A0</td> <td>XP BULB HOLDER PLATE L224 7.5x0.4</td> <td>1.000</td> <td>PC</td> </tr> </tbody> </table>	Code	Description	Qty	UOM	RS1235A1	500W 230V GLASS CERAMIC ELEMENT	1.000	PC	RS1259A0	XP BULB HOLDER PLATE L224 7.5x0.4	1.000	PC																																							
Code	Description	Qty	UOM																																																		
RS1235A1	500W 230V GLASS CERAMIC ELEMENT	1.000	PC																																																		
RS1259A0	XP BULB HOLDER PLATE L224 7.5x0.4	1.000	PC																																																		
GN1322A	EXT Ø 27 INT Ø 10 GASKET		KML1020A	XP-SP SPIDO ML1000A SPRINGS KIT	<table border="1"> <thead> <tr> <th>Code</th> <th>Description</th> <th>Qty</th> <th>UOM</th> </tr> </thead> <tbody> <tr> <td>0H2517A0</td> <td>BRACKET SIDE SPRINGS SEAT</td> <td>1.000</td> <td>PC</td> </tr> <tr> <td>0H2518A0</td> <td>HANDLE SIDE SPRINGS SEA</td> <td>1.000</td> <td>PC</td> </tr> <tr> <td>GN1322A0</td> <td>EXT Ø 27 INT Ø 10 GASKET</td> <td>2.000</td> <td>PC</td> </tr> <tr> <td>ML1000A1</td> <td>De24.4 H44 12 TURNS TORSION SPRING</td> <td>2.000</td> <td>PC</td> </tr> <tr> <td>VI1047A0</td> <td>SCREW M5x10 TSP+ ZINC.TO THICKNE.12</td> <td>2.000</td> <td>PC</td> </tr> <tr> <td>VI1093A0</td> <td>M10X30 TCEI 12.9 UNI5931 SCREW</td> <td>1.000</td> <td>PC</td> </tr> <tr> <td>VI1096A0</td> <td>M10x110 TCEI SCREW</td> <td>1.000</td> <td>PC</td> </tr> <tr> <td>VI1303A0</td> <td>M10 H6 ZN LOW NUT</td> <td>4.000</td> <td>PC</td> </tr> <tr> <td>VI1451A0</td> <td>10X20X0.5 BRASS NICKEL FLAT WASHER</td> <td>1.000</td> <td>PC</td> </tr> <tr> <td>VI1528A0</td> <td>10X30X2 ZN FLAT WASHER</td> <td>2.000</td> <td>PC</td> </tr> <tr> <td>VM1512A0</td> <td>SPIDO.COOK SPRING FIXING RING</td> <td>2.000</td> <td>PC</td> </tr> </tbody> </table>	Code	Description	Qty	UOM	0H2517A0	BRACKET SIDE SPRINGS SEAT	1.000	PC	0H2518A0	HANDLE SIDE SPRINGS SEA	1.000	PC	GN1322A0	EXT Ø 27 INT Ø 10 GASKET	2.000	PC	ML1000A1	De24.4 H44 12 TURNS TORSION SPRING	2.000	PC	VI1047A0	SCREW M5x10 TSP+ ZINC.TO THICKNE.12	2.000	PC	VI1093A0	M10X30 TCEI 12.9 UNI5931 SCREW	1.000	PC	VI1096A0	M10x110 TCEI SCREW	1.000	PC	VI1303A0	M10 H6 ZN LOW NUT	4.000	PC	VI1451A0	10X20X0.5 BRASS NICKEL FLAT WASHER	1.000	PC	VI1528A0	10X30X2 ZN FLAT WASHER	2.000	PC	VM1512A0	SPIDO.COOK SPRING FIXING RING	2.000	PC
Code	Description	Qty	UOM																																																		
0H2517A0	BRACKET SIDE SPRINGS SEAT	1.000	PC																																																		
0H2518A0	HANDLE SIDE SPRINGS SEA	1.000	PC																																																		
GN1322A0	EXT Ø 27 INT Ø 10 GASKET	2.000	PC																																																		
ML1000A1	De24.4 H44 12 TURNS TORSION SPRING	2.000	PC																																																		
VI1047A0	SCREW M5x10 TSP+ ZINC.TO THICKNE.12	2.000	PC																																																		
VI1093A0	M10X30 TCEI 12.9 UNI5931 SCREW	1.000	PC																																																		
VI1096A0	M10x110 TCEI SCREW	1.000	PC																																																		
VI1303A0	M10 H6 ZN LOW NUT	4.000	PC																																																		
VI1451A0	10X20X0.5 BRASS NICKEL FLAT WASHER	1.000	PC																																																		
VI1528A0	10X30X2 ZN FLAT WASHER	2.000	PC																																																		
VM1512A0	SPIDO.COOK SPRING FIXING RING	2.000	PC																																																		

COMPONENT			SPARE PART																																																																							
Code	Description	Image	Code	Description	Kit components																																																																					
GN1322A	EXT Ø 27 INT Ø 10 GASKET		KML0039A	XP SPRING RETROFIT KIT	<table border="1"> <thead> <tr> <th>Code</th> <th>Description</th> <th>Qty</th> <th>UOM</th> </tr> </thead> <tbody> <tr> <td>0H0159A0</td> <td>CONTACT GRILL HANDLE SUPPORT DOUBLE</td> <td>1.000</td> <td>PC</td> </tr> <tr> <td>0H2517A0</td> <td>BRACKET SIDE SPRINGS SEAT</td> <td>1.000</td> <td>PC</td> </tr> <tr> <td>0H2518A0</td> <td>HANDLE SIDE SPRINGS SEA</td> <td>1.000</td> <td>PC</td> </tr> <tr> <td>0H4816A0</td> <td>XP CONTACT GRILL RIGHT HANDLE BRACKET</td> <td>1.000</td> <td>PC</td> </tr> <tr> <td>GN1322A0</td> <td>EXT Ø 27 INT Ø 10 GASKET</td> <td>2.000</td> <td>PC</td> </tr> <tr> <td>ML1000A1</td> <td>De24.4 H44 12 TURNS TORSION SPRING</td> <td>1.000</td> <td>PC</td> </tr> <tr> <td>VI1047A0</td> <td>SCREW M5x10 TSP+ ZINC.TO THICKNE.12</td> <td>1.000</td> <td>PC</td> </tr> <tr> <td>VI1093A0</td> <td>M10X30 TCEI 12.9 UNI5931 SCREW</td> <td>1.000</td> <td>PC</td> </tr> <tr> <td>VI1096A0</td> <td>M10x110 TCEI SCREW</td> <td>1.000</td> <td>PC</td> </tr> <tr> <td>VI1303A0</td> <td>M10 H6 ZN LOW NUT</td> <td>4.000</td> <td>PC</td> </tr> <tr> <td>VI1451A0</td> <td>10X20X0.5 BRASS NICKEL FLAT WASHER</td> <td>1.000</td> <td>PC</td> </tr> <tr> <td>VI1528A0</td> <td>10X30X2 ZN FLAT WASHER</td> <td>2.000</td> <td>PC</td> </tr> <tr> <td>VI1605A0</td> <td>BUSHINGS M5 FTT-C-TC KNURLED</td> <td>1.000</td> <td>PC</td> </tr> <tr> <td>VM1512A0</td> <td>SPIDO.COOK SPRING FIXING RING</td> <td>1.000</td> <td>PC</td> </tr> </tbody> </table>	Code	Description	Qty	UOM	0H0159A0	CONTACT GRILL HANDLE SUPPORT DOUBLE	1.000	PC	0H2517A0	BRACKET SIDE SPRINGS SEAT	1.000	PC	0H2518A0	HANDLE SIDE SPRINGS SEA	1.000	PC	0H4816A0	XP CONTACT GRILL RIGHT HANDLE BRACKET	1.000	PC	GN1322A0	EXT Ø 27 INT Ø 10 GASKET	2.000	PC	ML1000A1	De24.4 H44 12 TURNS TORSION SPRING	1.000	PC	VI1047A0	SCREW M5x10 TSP+ ZINC.TO THICKNE.12	1.000	PC	VI1093A0	M10X30 TCEI 12.9 UNI5931 SCREW	1.000	PC	VI1096A0	M10x110 TCEI SCREW	1.000	PC	VI1303A0	M10 H6 ZN LOW NUT	4.000	PC	VI1451A0	10X20X0.5 BRASS NICKEL FLAT WASHER	1.000	PC	VI1528A0	10X30X2 ZN FLAT WASHER	2.000	PC	VI1605A0	BUSHINGS M5 FTT-C-TC KNURLED	1.000	PC	VM1512A0	SPIDO.COOK SPRING FIXING RING	1.000	PC	<table border="1"> <thead> <tr> <th>Code</th> <th>Description</th> <th>Qty</th> <th>UOM</th> </tr> </thead> <tbody> <tr> <td>GN1322A0</td> <td>EXT Ø 27 INT Ø 10 GASKET</td> <td>2.000</td> <td>PC</td> </tr> </tbody> </table>	Code	Description	Qty	UOM	GN1322A0	EXT Ø 27 INT Ø 10 GASKET	2.000	PC
			Code	Description	Qty	UOM																																																																				
0H0159A0	CONTACT GRILL HANDLE SUPPORT DOUBLE	1.000	PC																																																																							
0H2517A0	BRACKET SIDE SPRINGS SEAT	1.000	PC																																																																							
0H2518A0	HANDLE SIDE SPRINGS SEA	1.000	PC																																																																							
0H4816A0	XP CONTACT GRILL RIGHT HANDLE BRACKET	1.000	PC																																																																							
GN1322A0	EXT Ø 27 INT Ø 10 GASKET	2.000	PC																																																																							
ML1000A1	De24.4 H44 12 TURNS TORSION SPRING	1.000	PC																																																																							
VI1047A0	SCREW M5x10 TSP+ ZINC.TO THICKNE.12	1.000	PC																																																																							
VI1093A0	M10X30 TCEI 12.9 UNI5931 SCREW	1.000	PC																																																																							
VI1096A0	M10x110 TCEI SCREW	1.000	PC																																																																							
VI1303A0	M10 H6 ZN LOW NUT	4.000	PC																																																																							
VI1451A0	10X20X0.5 BRASS NICKEL FLAT WASHER	1.000	PC																																																																							
VI1528A0	10X30X2 ZN FLAT WASHER	2.000	PC																																																																							
VI1605A0	BUSHINGS M5 FTT-C-TC KNURLED	1.000	PC																																																																							
VM1512A0	SPIDO.COOK SPRING FIXING RING	1.000	PC																																																																							
Code	Description	Qty	UOM																																																																							
GN1322A0	EXT Ø 27 INT Ø 10 GASKET	2.000	PC																																																																							
			KG1322A	GASKET KIT DE27 DI10 SP2																																																																						

COMPONENT			SPARE PART																																						
Code	Description	Image	Code	Description	Kit components																																				
IE1510A	UPPER HEATING EL. XP SERIES WIRING KIT		KIE1510A	UPPER HEAT.ELEMENT SERIE XP WIRE KIT	<table border="1"> <thead> <tr> <th>Code</th> <th>Description</th> <th>Qty</th> <th>UOM</th> </tr> </thead> <tbody> <tr> <td>GN1095A0</td> <td>Ø14 - L=30 NEOPRENE SLEEVE</td> <td>1.000</td> <td>PC</td> </tr> <tr> <td>IE1510A0</td> <td>UPPER HEATING EL. XP SERIES WIRING KIT</td> <td>1.000</td> <td>PC</td> </tr> </tbody> </table>	Code	Description	Qty	UOM	GN1095A0	Ø14 - L=30 NEOPRENE SLEEVE	1.000	PC	IE1510A0	UPPER HEATING EL. XP SERIES WIRING KIT	1.000	PC																								
Code	Description	Qty	UOM																																						
GN1095A0	Ø14 - L=30 NEOPRENE SLEEVE	1.000	PC																																						
IE1510A0	UPPER HEATING EL. XP SERIES WIRING KIT	1.000	PC																																						
MG1040A	CLAMPSHELL GRILL UPPER HANDLE		KMG1040A	CLAMPSHELL GRILL HANDLE KIT	<table border="1"> <thead> <tr> <th>Code</th> <th>Description</th> <th>Qty</th> <th>UOM</th> </tr> </thead> <tbody> <tr> <td>MG1040A1</td> <td>CLAMPSHELL GRILL UPPER HANDLE</td> <td>1.000</td> <td>PC</td> </tr> <tr> <td>MG1041A0</td> <td>XP SERIES LOWER HANDLE</td> <td>1.000</td> <td>PC</td> </tr> <tr> <td>VI1955A0</td> <td>ST STEEL CROSS SCREW 4x20</td> <td>2.000</td> <td>PC</td> </tr> </tbody> </table>	Code	Description	Qty	UOM	MG1040A1	CLAMPSHELL GRILL UPPER HANDLE	1.000	PC	MG1041A0	XP SERIES LOWER HANDLE	1.000	PC	VI1955A0	ST STEEL CROSS SCREW 4x20	2.000	PC																				
Code	Description	Qty	UOM																																						
MG1040A1	CLAMPSHELL GRILL UPPER HANDLE	1.000	PC																																						
MG1041A0	XP SERIES LOWER HANDLE	1.000	PC																																						
VI1955A0	ST STEEL CROSS SCREW 4x20	2.000	PC																																						
MG1041A	XP SERIES LOWER HANDLE		KMG1040A	CLAMPSHELL GRILL HANDLE KIT	<table border="1"> <thead> <tr> <th>Code</th> <th>Description</th> <th>Qty</th> <th>UOM</th> </tr> </thead> <tbody> <tr> <td>MG1040A1</td> <td>CLAMPSHELL GRILL UPPER HANDLE</td> <td>1.000</td> <td>PC</td> </tr> <tr> <td>MG1041A0</td> <td>XP SERIES LOWER HANDLE</td> <td>1.000</td> <td>PC</td> </tr> <tr> <td>VI1955A0</td> <td>ST STEEL CROSS SCREW 4x20</td> <td>2.000</td> <td>PC</td> </tr> </tbody> </table>	Code	Description	Qty	UOM	MG1040A1	CLAMPSHELL GRILL UPPER HANDLE	1.000	PC	MG1041A0	XP SERIES LOWER HANDLE	1.000	PC	VI1955A0	ST STEEL CROSS SCREW 4x20	2.000	PC																				
Code	Description	Qty	UOM																																						
MG1040A1	CLAMPSHELL GRILL UPPER HANDLE	1.000	PC																																						
MG1041A0	XP SERIES LOWER HANDLE	1.000	PC																																						
VI1955A0	ST STEEL CROSS SCREW 4x20	2.000	PC																																						
ML1000A	WIRE D3.2 EXT. D24 H44 TORSION SPRING		KML1020A	XP-SP SPIDO ML1000A SPRINGS KIT	<table border="1"> <thead> <tr> <th>Code</th> <th>Description</th> <th>Qty</th> <th>UOM</th> </tr> </thead> <tbody> <tr> <td>0H2517A0</td> <td>BRACKET SIDE SPRINGS SEAT</td> <td>1.000</td> <td>PC</td> </tr> <tr> <td>0H2518A0</td> <td>HANDLE SIDE SPRINGS SEA</td> <td>1.000</td> <td>PC</td> </tr> <tr> <td>GN1322A0</td> <td>EXT Ø 27 INT Ø 10 GASKET</td> <td>2.000</td> <td>PC</td> </tr> <tr> <td>ML1000A1</td> <td>De24.4 H44 12 TURNS TORSION SPRING</td> <td>2.000</td> <td>PC</td> </tr> <tr> <td>VI1047A0</td> <td>SCREW M5x10 TSP+ ZINC.TO THICKNE.12</td> <td>2.000</td> <td>PC</td> </tr> <tr> <td>VI1093A0</td> <td>M10X30 TCEI 12.9 UNI5931 SCREW</td> <td>1.000</td> <td>PC</td> </tr> <tr> <td>VI1096A0</td> <td>M10x110 TCEI SCREW</td> <td>1.000</td> <td>PC</td> </tr> <tr> <td>VI1303A0</td> <td>M10 H6 ZN LOW NUT</td> <td>4.000</td> <td>PC</td> </tr> </tbody> </table>	Code	Description	Qty	UOM	0H2517A0	BRACKET SIDE SPRINGS SEAT	1.000	PC	0H2518A0	HANDLE SIDE SPRINGS SEA	1.000	PC	GN1322A0	EXT Ø 27 INT Ø 10 GASKET	2.000	PC	ML1000A1	De24.4 H44 12 TURNS TORSION SPRING	2.000	PC	VI1047A0	SCREW M5x10 TSP+ ZINC.TO THICKNE.12	2.000	PC	VI1093A0	M10X30 TCEI 12.9 UNI5931 SCREW	1.000	PC	VI1096A0	M10x110 TCEI SCREW	1.000	PC	VI1303A0	M10 H6 ZN LOW NUT	4.000	PC
Code	Description	Qty	UOM																																						
0H2517A0	BRACKET SIDE SPRINGS SEAT	1.000	PC																																						
0H2518A0	HANDLE SIDE SPRINGS SEA	1.000	PC																																						
GN1322A0	EXT Ø 27 INT Ø 10 GASKET	2.000	PC																																						
ML1000A1	De24.4 H44 12 TURNS TORSION SPRING	2.000	PC																																						
VI1047A0	SCREW M5x10 TSP+ ZINC.TO THICKNE.12	2.000	PC																																						
VI1093A0	M10X30 TCEI 12.9 UNI5931 SCREW	1.000	PC																																						
VI1096A0	M10x110 TCEI SCREW	1.000	PC																																						
VI1303A0	M10 H6 ZN LOW NUT	4.000	PC																																						

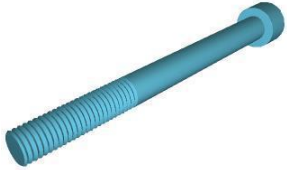
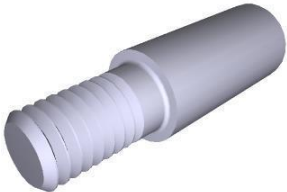
COMPONENT			SPARE PART																																																		
Code	Description	Image	Code	Description	Kit components																																																
ML1000A	WIRE D3.2 EXT. D24 H44 TORSION SPRING		KML1020A	XP-SP SPIDO ML1000A SPRINGS KIT	<table border="1"> <thead> <tr> <th>Code</th> <th>Description</th> <th>Qty</th> <th>UOM</th> </tr> </thead> <tbody> <tr> <td>V11451A0</td> <td>10X20X0.5 BRASS NICKEL FLAT WASHER</td> <td>1.000</td> <td>PC</td> </tr> <tr> <td>V11528A0</td> <td>10X30X2 ZN FLAT WASHER</td> <td>2.000</td> <td>PC</td> </tr> <tr> <td>VM1512A0</td> <td>SPIDO.COOK SPRING FIXING RING</td> <td>2.000</td> <td>PC</td> </tr> </tbody> </table>	Code	Description	Qty	UOM	V11451A0	10X20X0.5 BRASS NICKEL FLAT WASHER	1.000	PC	V11528A0	10X30X2 ZN FLAT WASHER	2.000	PC	VM1512A0	SPIDO.COOK SPRING FIXING RING	2.000	PC																																
Code	Description	Qty	UOM																																																		
V11451A0	10X20X0.5 BRASS NICKEL FLAT WASHER	1.000	PC																																																		
V11528A0	10X30X2 ZN FLAT WASHER	2.000	PC																																																		
VM1512A0	SPIDO.COOK SPRING FIXING RING	2.000	PC																																																		
TB1505A	STAINLESS STEEL BENDEDE TUBE D13		KTB1505A	WIRES GUIDE TUBE KIT	<table border="1"> <thead> <tr> <th>Code</th> <th>Description</th> <th>Qty</th> <th>UOM</th> </tr> </thead> <tbody> <tr> <td>CE1155A0</td> <td>6,3x0,81 - 2,5 ALPACA FEMALE FASTON</td> <td>1.000</td> <td>PC</td> </tr> <tr> <td>CE1270A0</td> <td>YELL/GREEN UNIP SIL RUBB WIRE D 0,75MMQ</td> <td>0.280</td> <td>M</td> </tr> <tr> <td>CE1330A0</td> <td>3 WAYS MALE INAR-LOCK CONNECTOR</td> <td>1.000</td> <td>PC</td> </tr> <tr> <td>CE1350A0</td> <td>MALE INAR-LOCK END CONNECTOR</td> <td>3.000</td> <td>PC</td> </tr> <tr> <td>CE1430A0</td> <td>BROWN UNIP. CABLE Ø1,5 MMQ</td> <td>0.350</td> <td>M</td> </tr> <tr> <td>CE1435A0</td> <td>BLUE UNIP. CABLE Ø1,5 MMQ</td> <td>0.350</td> <td>M</td> </tr> <tr> <td>CE1455A0</td> <td>TIP END FITTING</td> <td>2.000</td> <td>PC</td> </tr> <tr> <td>GN1095A0</td> <td>Ø14 - L=30 NEOPRENE SLEEVE</td> <td>2.000</td> <td>PC</td> </tr> <tr> <td>TB1505A0</td> <td>STAINLESS STEEL BENDEDE TUBE D13</td> <td>1.000</td> <td>PC</td> </tr> <tr> <td>V11640A0</td> <td>BRASS NUT M13x1 H7 CH1</td> <td>1.000</td> <td>PC</td> </tr> <tr> <td>V11645A0</td> <td>NICKEL BRASS NUT M13x1 H4 CH1</td> <td>1.000</td> <td>PC</td> </tr> </tbody> </table>	Code	Description	Qty	UOM	CE1155A0	6,3x0,81 - 2,5 ALPACA FEMALE FASTON	1.000	PC	CE1270A0	YELL/GREEN UNIP SIL RUBB WIRE D 0,75MMQ	0.280	M	CE1330A0	3 WAYS MALE INAR-LOCK CONNECTOR	1.000	PC	CE1350A0	MALE INAR-LOCK END CONNECTOR	3.000	PC	CE1430A0	BROWN UNIP. CABLE Ø1,5 MMQ	0.350	M	CE1435A0	BLUE UNIP. CABLE Ø1,5 MMQ	0.350	M	CE1455A0	TIP END FITTING	2.000	PC	GN1095A0	Ø14 - L=30 NEOPRENE SLEEVE	2.000	PC	TB1505A0	STAINLESS STEEL BENDEDE TUBE D13	1.000	PC	V11640A0	BRASS NUT M13x1 H7 CH1	1.000	PC	V11645A0	NICKEL BRASS NUT M13x1 H4 CH1	1.000	PC
Code	Description	Qty	UOM																																																		
CE1155A0	6,3x0,81 - 2,5 ALPACA FEMALE FASTON	1.000	PC																																																		
CE1270A0	YELL/GREEN UNIP SIL RUBB WIRE D 0,75MMQ	0.280	M																																																		
CE1330A0	3 WAYS MALE INAR-LOCK CONNECTOR	1.000	PC																																																		
CE1350A0	MALE INAR-LOCK END CONNECTOR	3.000	PC																																																		
CE1430A0	BROWN UNIP. CABLE Ø1,5 MMQ	0.350	M																																																		
CE1435A0	BLUE UNIP. CABLE Ø1,5 MMQ	0.350	M																																																		
CE1455A0	TIP END FITTING	2.000	PC																																																		
GN1095A0	Ø14 - L=30 NEOPRENE SLEEVE	2.000	PC																																																		
TB1505A0	STAINLESS STEEL BENDEDE TUBE D13	1.000	PC																																																		
V11640A0	BRASS NUT M13x1 H7 CH1	1.000	PC																																																		
V11645A0	NICKEL BRASS NUT M13x1 H4 CH1	1.000	PC																																																		



COMPONENT			SPARE PART														
Code	Description	Image	Code	Description	Kit components												
TB1830A	CLAMPSHELL GRILL HANDLE TUBE		KTB1830A	SP010 SP020 CONT GRILL HANDLE TUBE KIT	<table border="1"> <thead> <tr> <th>Code</th> <th>Description</th> <th>Qty</th> <th>UOM</th> </tr> </thead> <tbody> <tr> <td>TB1830A2</td> <td></td> <td>1.000</td> <td>PC</td> </tr> <tr> <td>V11605A0</td> <td>BUSHINGS M5 FTT-C-TC KNURLED</td> <td>1.000</td> <td>PC</td> </tr> </tbody> </table>	Code	Description	Qty	UOM	TB1830A2		1.000	PC	V11605A0	BUSHINGS M5 FTT-C-TC KNURLED	1.000	PC
					Code	Description	Qty	UOM									
TB1830A2		1.000	PC														
V11605A0	BUSHINGS M5 FTT-C-TC KNURLED	1.000	PC														
V11096A	M10x110 TCEI SCRE		KVI1096A	M10x110 SCREW 10 PCS. KIT	<table border="1"> <thead> <tr> <th>Code</th> <th>Description</th> <th>Qty</th> <th>UOM</th> </tr> </thead> <tbody> <tr> <td>V11096A0</td> <td>M10x110 TCEI SCREW</td> <td>10.000</td> <td>PC</td> </tr> </tbody> </table>	Code	Description	Qty	UOM	V11096A0	M10x110 TCEI SCREW	10.000	PC				
					Code	Description	Qty	UOM									
V11096A0	M10x110 TCEI SCREW	10.000	PC														
V11655A	LID FULCRUM PIN D6.8 M5x0.8 H23		KVI1655A	LID FULCRUM PIN 4 PCS. KIT	<table border="1"> <thead> <tr> <th>Code</th> <th>Description</th> <th>Qty</th> <th>UOM</th> </tr> </thead> <tbody> <tr> <td>V11655A0</td> <td>LID FULCRUM PIN D6.8 M5x0.8 H23</td> <td>4.000</td> <td>PC</td> </tr> </tbody> </table>	Code	Description	Qty	UOM	V11655A0	LID FULCRUM PIN D6.8 M5x0.8 H23	4.000	PC				
					Code	Description	Qty	UOM									
V11655A0	LID FULCRUM PIN D6.8 M5x0.8 H23	4.000	PC														
VT1226A	250x250x4 BLACK RIBBED GLASS CERAMIC		VT1226A0	250x250x4 BLACK RIBBED GLASS CERAMIC													

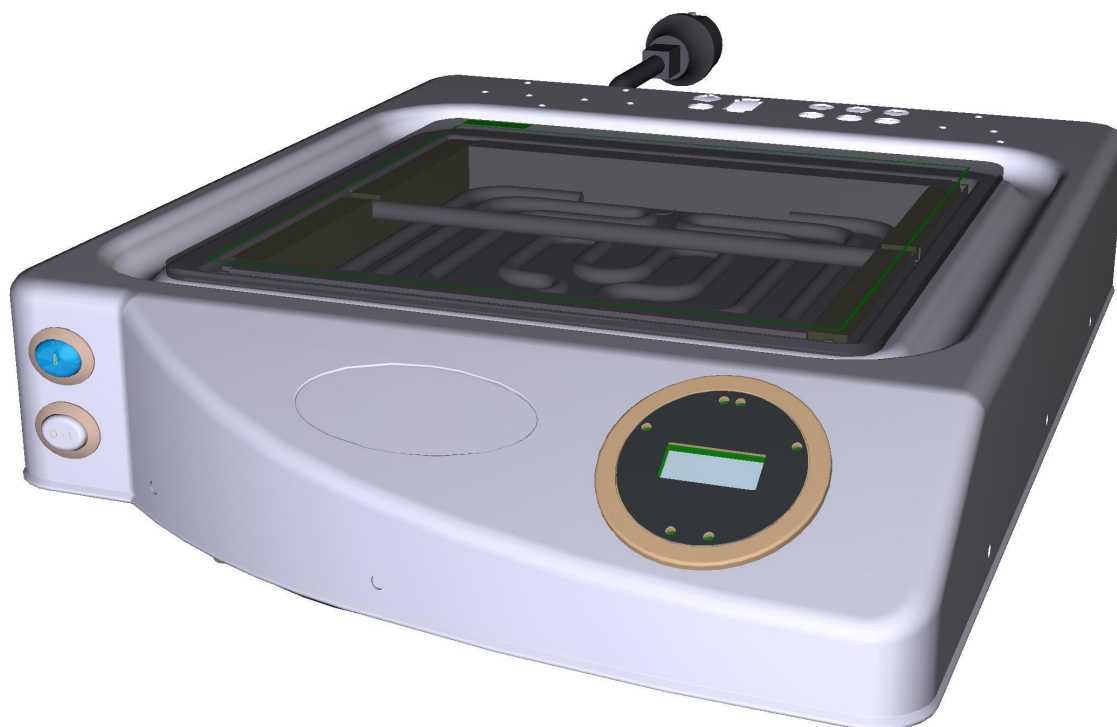

ASM0091B/0.D00 - General overview - FRONT



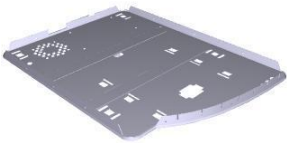
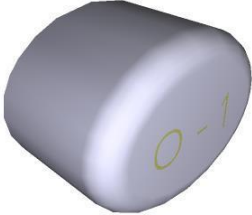
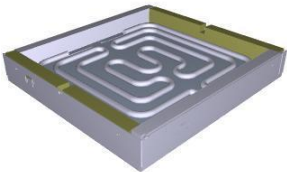

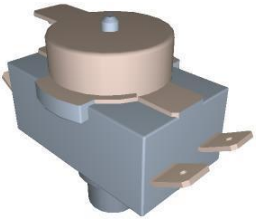

ASM0091B/0.D00 - General overview - REAR

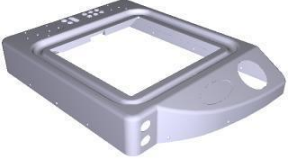
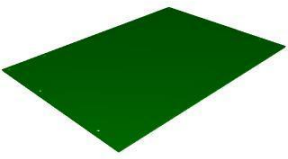

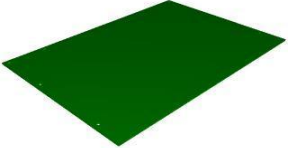

COMPONENT			SPARE PART																		
Code	Description	Image	Code	Description	Kit components																
0E1270B	SINGLE XP EXTERNAL BOTTOM PANEL		0E1270B1	SINGLE XP EXTERNAL BOTTOM PANEL																	
VM1776A	"GOLD ""0-1"" MATT SILVER KEY"		KVE0108A	0 - 1 SWITCH BUTTON KIT	<table border="1"> <thead> <tr> <th>Code</th> <th>Description</th> <th>Qty</th> <th>UOM</th> </tr> </thead> <tbody> <tr> <td>VE1170A0</td> <td>D16 OPAQUE NICKEL ELLIPTICAL SUPPORT</td> <td>2.000</td> <td>PC</td> </tr> <tr> <td>VE1561A0</td> <td>NA/NA BIPOLAR SWITCH</td> <td>1.000</td> <td>PC</td> </tr> <tr> <td>VM1776A0</td> <td>"GOLD ""0-1"" MATT SILVER KEY"</td> <td>1.000</td> <td>PC</td> </tr> </tbody> </table>	Code	Description	Qty	UOM	VE1170A0	D16 OPAQUE NICKEL ELLIPTICAL SUPPORT	2.000	PC	VE1561A0	NA/NA BIPOLAR SWITCH	1.000	PC	VM1776A0	"GOLD ""0-1"" MATT SILVER KEY"	1.000	PC
Code	Description	Qty	UOM																		
VE1170A0	D16 OPAQUE NICKEL ELLIPTICAL SUPPORT	2.000	PC																		
VE1561A0	NA/NA BIPOLAR SWITCH	1.000	PC																		
VM1776A0	"GOLD ""0-1"" MATT SILVER KEY"	1.000	PC																		
RS1258A	750W 230V GLASS CERAMIC HEATING ELEMENT		KRS1258A	750W 230V GLASS CER.HEATING EL.KI	<table border="1"> <thead> <tr> <th>Code</th> <th>Description</th> <th>Qty</th> <th>UOM</th> </tr> </thead> <tbody> <tr> <td>RS1258A0</td> <td>750W 230V GLASS CERAMIC HEATING ELEMENT</td> <td>1.000</td> <td>PC</td> </tr> <tr> <td>RS1259A0</td> <td>XP BULB HOLDER PLATE L224 7.5x0.4</td> <td>1.000</td> <td>PC</td> </tr> </tbody> </table>	Code	Description	Qty	UOM	RS1258A0	750W 230V GLASS CERAMIC HEATING ELEMENT	1.000	PC	RS1259A0	XP BULB HOLDER PLATE L224 7.5x0.4	1.000	PC				
Code	Description	Qty	UOM																		
RS1258A0	750W 230V GLASS CERAMIC HEATING ELEMENT	1.000	PC																		
RS1259A0	XP BULB HOLDER PLATE L224 7.5x0.4	1.000	PC																		
RS1259A	XP BULB HOLDER PLATE L224 7.5x0.4		KRS1258A	750W 230V GLASS CER.HEATING EL.KI	<table border="1"> <thead> <tr> <th>Code</th> <th>Description</th> <th>Qty</th> <th>UOM</th> </tr> </thead> <tbody> <tr> <td>RS1258A0</td> <td>750W 230V GLASS CERAMIC HEATING ELEMENT</td> <td>1.000</td> <td>PC</td> </tr> <tr> <td>RS1259A0</td> <td>XP BULB HOLDER PLATE L224 7.5x0.4</td> <td>1.000</td> <td>PC</td> </tr> </tbody> </table>	Code	Description	Qty	UOM	RS1258A0	750W 230V GLASS CERAMIC HEATING ELEMENT	1.000	PC	RS1259A0	XP BULB HOLDER PLATE L224 7.5x0.4	1.000	PC				
Code	Description	Qty	UOM																		
RS1258A0	750W 230V GLASS CERAMIC HEATING ELEMENT	1.000	PC																		
RS1259A0	XP BULB HOLDER PLATE L224 7.5x0.4	1.000	PC																		
			KRS1235A	500W 230V GLASS CER. HEATING EL.KI	<table border="1"> <thead> <tr> <th>Code</th> <th>Description</th> <th>Qty</th> <th>UOM</th> </tr> </thead> <tbody> <tr> <td>RS1235A1</td> <td>500W 230V GLASS CERAMIC ELEMENT</td> <td>1.000</td> <td>PC</td> </tr> <tr> <td>RS1259A0</td> <td>XP BULB HOLDER PLATE L224 7.5x0.4</td> <td>1.000</td> <td>PC</td> </tr> </tbody> </table>	Code	Description	Qty	UOM	RS1235A1	500W 230V GLASS CERAMIC ELEMENT	1.000	PC	RS1259A0	XP BULB HOLDER PLATE L224 7.5x0.4	1.000	PC				
Code	Description	Qty	UOM																		
RS1235A1	500W 230V GLASS CERAMIC ELEMENT	1.000	PC																		
RS1259A0	XP BULB HOLDER PLATE L224 7.5x0.4	1.000	PC																		

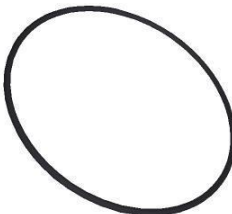
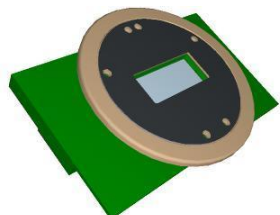

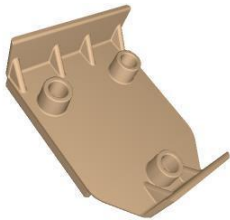

COMPONENT			SPARE PART										
Code	Description	Image	Code	Description	Kit components								
TR1134A	335°C BIPOLAR SAFETY THERMOSTAT		KTR1149A	XP/SP015 335° BIP HIGH LIMIT SWITCH KIT	<table border="1"> <thead> <tr> <th>Code</th> <th>Description</th> <th>Qty</th> <th>UOM</th> </tr> </thead> <tbody> <tr> <td>TR1134A0</td> <td>335°C BIPOLAR SAFETY THERMOSTAT</td> <td>1.000</td> <td>PC</td> </tr> </tbody> </table>	Code	Description	Qty	UOM	TR1134A0	335°C BIPOLAR SAFETY THERMOSTAT	1.000	PC
			Code	Description	Qty	UOM							
			TR1134A0	335°C BIPOLAR SAFETY THERMOSTAT	1.000	PC							
KTR1148A	XP/SP010/020 335° BIP SAFETY SWITCH KIT	<table border="1"> <thead> <tr> <th>Code</th> <th>Description</th> <th>Qty</th> <th>UOM</th> </tr> </thead> <tbody> <tr> <td>TR1134A0</td> <td>335°C BIPOLAR SAFETY THERMOSTAT</td> <td>1.000</td> <td>PC</td> </tr> </tbody> </table>	Code	Description	Qty	UOM	TR1134A0	335°C BIPOLAR SAFETY THERMOSTAT	1.000	PC			
Code	Description	Qty	UOM										
TR1134A0	335°C BIPOLAR SAFETY THERMOSTAT	1.000	PC										
KTR1134A	335°C SAFETY THERMOSTAT KIT	<table border="1"> <thead> <tr> <th>Code</th> <th>Description</th> <th>Qty</th> <th>UOM</th> </tr> </thead> <tbody> <tr> <td>TR1134A0</td> <td>335°C BIPOLAR SAFETY THERMOSTAT</td> <td>1.000</td> <td>PC</td> </tr> </tbody> </table>	Code	Description	Qty	UOM	TR1134A0	335°C BIPOLAR SAFETY THERMOSTAT	1.000	PC			
Code	Description	Qty	UOM										
TR1134A0	335°C BIPOLAR SAFETY THERMOSTAT	1.000	PC										
VM1750A	BRASS COMB CLAM		KVM1750A	COMB TERMINAL BLOCK KIT	<table border="1"> <thead> <tr> <th>Code</th> <th>Description</th> <th>Qty</th> <th>UOM</th> </tr> </thead> <tbody> <tr> <td>VI1040A0</td> <td>INDENTED INTERNAL WASHER D=6 ZN</td> <td>2.000</td> <td>PC</td> </tr> </tbody> </table>	Code	Description	Qty	UOM	VI1040A0	INDENTED INTERNAL WASHER D=6 ZN	2.000	PC
					Code	Description	Qty	UOM					
VI1040A0	INDENTED INTERNAL WASHER D=6 ZN	2.000	PC										
<table border="1"> <thead> <tr> <th>Code</th> <th>Description</th> <th>Qty</th> <th>UOM</th> </tr> </thead> <tbody> <tr> <td>VM1750A0</td> <td>BRASS COMB CLAMP</td> <td>1.000</td> <td>PC</td> </tr> </tbody> </table>	Code	Description	Qty	UOM	VM1750A0	BRASS COMB CLAMP	1.000	PC					
Code	Description	Qty	UOM										
VM1750A0	BRASS COMB CLAMP	1.000	PC										
0D2015B	DIGITAL XP SINGLE BASE PANEL		0D2015B0	DIGITAL XP SINGLE BASE PANEL									
PE1790C	SpidoCook POWER CARD		KPE1790C	POWER BOARD KIT	<table border="1"> <thead> <tr> <th>Code</th> <th>Description</th> <th>Qty</th> <th>UOM</th> </tr> </thead> <tbody> <tr> <td>CE1155A0</td> <td>6,3x0,81 - 2,5 ALPACA FEMALE FASTON</td> <td>4.000</td> <td>PC</td> </tr> </tbody> </table>	Code	Description	Qty	UOM	CE1155A0	6,3x0,81 - 2,5 ALPACA FEMALE FASTON	4.000	PC
					Code	Description	Qty	UOM					
					CE1155A0	6,3x0,81 - 2,5 ALPACA FEMALE FASTON	4.000	PC					
					<table border="1"> <thead> <tr> <th>Code</th> <th>Description</th> <th>Qty</th> <th>UOM</th> </tr> </thead> <tbody> <tr> <td>CE1165A0</td> <td>Cu+Sn BROWN UNIP SIL RUBB WIRE D2,5MMQ</td> <td>0.600</td> <td>M</td> </tr> </tbody> </table>	Code	Description	Qty	UOM	CE1165A0	Cu+Sn BROWN UNIP SIL RUBB WIRE D2,5MMQ	0.600	M
Code	Description	Qty	UOM										
CE1165A0	Cu+Sn BROWN UNIP SIL RUBB WIRE D2,5MMQ	0.600	M										
<table border="1"> <thead> <tr> <th>Code</th> <th>Description</th> <th>Qty</th> <th>UOM</th> </tr> </thead> <tbody> <tr> <td>CE1285A0</td> <td>EMI ROUND FERRITE MOD.26438015 02</td> <td>1.000</td> <td>PC</td> </tr> </tbody> </table>	Code	Description	Qty	UOM	CE1285A0	EMI ROUND FERRITE MOD.26438015 02	1.000	PC					
Code	Description	Qty	UOM										
CE1285A0	EMI ROUND FERRITE MOD.26438015 02	1.000	PC										
<table border="1"> <thead> <tr> <th>Code</th> <th>Description</th> <th>Qty</th> <th>UOM</th> </tr> </thead> <tbody> <tr> <td>CE1660A0</td> <td>6,3x0,8 FEMALE FASTON COVE</td> <td>4.000</td> <td>PC</td> </tr> </tbody> </table>	Code	Description	Qty	UOM	CE1660A0	6,3x0,8 FEMALE FASTON COVE	4.000	PC					
Code	Description	Qty	UOM										
CE1660A0	6,3x0,8 FEMALE FASTON COVE	4.000	PC										

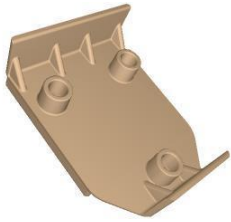
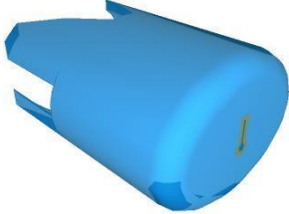
COMPONENT			SPARE PART																																															
Code	Description	Image	Code	Description	Kit components																																													
PE1790C	SpidoCook POWER CARD		KPE1790C	POWER BOARD KIT	<table border="1"> <thead> <tr> <th>Code</th> <th>Description</th> <th>Qty</th> <th>UOM</th> </tr> </thead> <tbody> <tr> <td>CE1725A0</td> <td>ROBOTICS SILICON PIPE 4x0.5 MMQ</td> <td>0.600</td> <td>M</td> </tr> <tr> <td>CE1735A0</td> <td>MINIFIT FEMALE END FITTING</td> <td>8.000</td> <td>PC</td> </tr> <tr> <td>CE1755A0</td> <td>4 WAYS MALE MINIFIT CONNECTOR</td> <td>2.000</td> <td>PC</td> </tr> <tr> <td>CE1771A1</td> <td>WARNING LIGHT CONNECTION CABLE</td> <td>1.000</td> <td>PC</td> </tr> <tr> <td>PE1790C0</td> <td>SpidoCook POWER CARD</td> <td>1.000</td> <td>PC</td> </tr> <tr> <td>VM1447A0</td> <td>MM 230x450 PINK ESD AIRBALL BAG</td> <td>1.000</td> <td>PC</td> </tr> </tbody> </table>	Code	Description	Qty	UOM	CE1725A0	ROBOTICS SILICON PIPE 4x0.5 MMQ	0.600	M	CE1735A0	MINIFIT FEMALE END FITTING	8.000	PC	CE1755A0	4 WAYS MALE MINIFIT CONNECTOR	2.000	PC	CE1771A1	WARNING LIGHT CONNECTION CABLE	1.000	PC	PE1790C0	SpidoCook POWER CARD	1.000	PC	VM1447A0	MM 230x450 PINK ESD AIRBALL BAG	1.000	PC																	
			Code	Description	Qty	UOM																																												
CE1725A0	ROBOTICS SILICON PIPE 4x0.5 MMQ	0.600	M																																															
CE1735A0	MINIFIT FEMALE END FITTING	8.000	PC																																															
CE1755A0	4 WAYS MALE MINIFIT CONNECTOR	2.000	PC																																															
CE1771A1	WARNING LIGHT CONNECTION CABLE	1.000	PC																																															
PE1790C0	SpidoCook POWER CARD	1.000	PC																																															
VM1447A0	MM 230x450 PINK ESD AIRBALL BAG	1.000	PC																																															
KPE0002A	SBUX XP010ER-SB BOARDS UPGRADE KIT	<table border="1"> <thead> <tr> <th>Code</th> <th>Description</th> <th>Qty</th> <th>UOM</th> </tr> </thead> <tbody> <tr> <td>CE1285A0</td> <td>EMI ROUND FERRITE MOD.26438015 02</td> <td>1.000</td> <td>PC</td> </tr> <tr> <td>CE1725A0</td> <td>ROBOTICS SILICON PIPE 4x0.5 MMQ</td> <td>0.600</td> <td>M</td> </tr> <tr> <td>CE1735A0</td> <td>MINIFIT FEMALE END FITTING</td> <td>8.000</td> <td>PC</td> </tr> <tr> <td>CE1755A0</td> <td>4 WAYS MALE MINIFIT CONNECTOR</td> <td>2.000</td> <td>PC</td> </tr> <tr> <td>PE1645B0</td> <td>12VDC Ø42MM EXTERNAL BUZZER</td> <td>1.000</td> <td>PC</td> </tr> <tr> <td>PE1790C0</td> <td>SpidoCook POWER CARD</td> <td>1.000</td> <td>PC</td> </tr> <tr> <td>PE1986B1</td> <td>SB SPIDOCOOK CONTROL BOARD</td> <td>1.000</td> <td>PC</td> </tr> <tr> <td>VI1951A0</td> <td>ZINC PLATED BLACK CROSS SCREW 3.5x16</td> <td>3.000</td> <td>PC</td> </tr> <tr> <td>VM1447A0</td> <td>MM 230x450 PINK ESD AIRBALL BAG</td> <td>1.000</td> <td>PC</td> </tr> <tr> <td>VM1745A0</td> <td>CARD SUPPORT</td> <td>7.000</td> <td>PC</td> </tr> <tr> <td>VM2022A0</td> <td>DIGITAL XP WIRING COVE</td> <td>1.000</td> <td>PC</td> </tr> </tbody> </table>	Code	Description	Qty	UOM	CE1285A0	EMI ROUND FERRITE MOD.26438015 02	1.000	PC	CE1725A0	ROBOTICS SILICON PIPE 4x0.5 MMQ	0.600	M	CE1735A0	MINIFIT FEMALE END FITTING	8.000	PC	CE1755A0	4 WAYS MALE MINIFIT CONNECTOR	2.000	PC	PE1645B0	12VDC Ø42MM EXTERNAL BUZZER	1.000	PC	PE1790C0	SpidoCook POWER CARD	1.000	PC	PE1986B1	SB SPIDOCOOK CONTROL BOARD	1.000	PC	VI1951A0	ZINC PLATED BLACK CROSS SCREW 3.5x16	3.000	PC	VM1447A0	MM 230x450 PINK ESD AIRBALL BAG	1.000	PC	VM1745A0	CARD SUPPORT	7.000	PC	VM2022A0	DIGITAL XP WIRING COVE	1.000	PC
Code	Description	Qty	UOM																																															
CE1285A0	EMI ROUND FERRITE MOD.26438015 02	1.000	PC																																															
CE1725A0	ROBOTICS SILICON PIPE 4x0.5 MMQ	0.600	M																																															
CE1735A0	MINIFIT FEMALE END FITTING	8.000	PC																																															
CE1755A0	4 WAYS MALE MINIFIT CONNECTOR	2.000	PC																																															
PE1645B0	12VDC Ø42MM EXTERNAL BUZZER	1.000	PC																																															
PE1790C0	SpidoCook POWER CARD	1.000	PC																																															
PE1986B1	SB SPIDOCOOK CONTROL BOARD	1.000	PC																																															
VI1951A0	ZINC PLATED BLACK CROSS SCREW 3.5x16	3.000	PC																																															
VM1447A0	MM 230x450 PINK ESD AIRBALL BAG	1.000	PC																																															
VM1745A0	CARD SUPPORT	7.000	PC																																															
VM2022A0	DIGITAL XP WIRING COVE	1.000	PC																																															

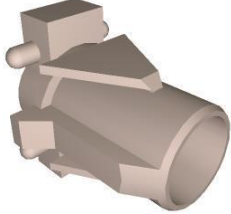
COMPONENT			SPARE PART																						
Code	Description	Image	Code	Description	Kit components																				
SN1025A	SN1025A0		KSN1025A	PT100 500 °C TEMPERATURE PROBE KIT	<table border="1"> <thead> <tr> <th>Code</th> <th>Description</th> <th>Qty</th> <th>UOM</th> </tr> </thead> <tbody> <tr> <td>SN1025A0</td> <td>SN1025A0</td> <td>1.000</td> <td>PC</td> </tr> </tbody> </table>	Code	Description	Qty	UOM	SN1025A0	SN1025A0	1.000	PC												
Code	Description	Qty	UOM																						
SN1025A0	SN1025A0	1.000	PC																						
VN1141A	COOLING DOWN FAN 12V 60x60x26		KVN1141A	DIGITAL CLAMPSHELL GRILL CONTROL FAN KIT	<table border="1"> <thead> <tr> <th>Code</th> <th>Description</th> <th>Qty</th> <th>UOM</th> </tr> </thead> <tbody> <tr> <td>V11865A0</td> <td>5X10 TCB+ SELF-THREADING SCREW</td> <td>4.000</td> <td>PC</td> </tr> <tr> <td>VN1141A1</td> <td>COOLING DOWN FAN 12V 60x60x26</td> <td>1.000</td> <td>PC</td> </tr> </tbody> </table>	Code	Description	Qty	UOM	V11865A0	5X10 TCB+ SELF-THREADING SCREW	4.000	PC	VN1141A1	COOLING DOWN FAN 12V 60x60x26	1.000	PC								
Code	Description	Qty	UOM																						
V11865A0	5X10 TCB+ SELF-THREADING SCREW	4.000	PC																						
VN1141A1	COOLING DOWN FAN 12V 60x60x26	1.000	PC																						
GN1507A	O-RING 2225		GN1507A0	O-RING 2225																					
PE2150A	4P 350 °C SPIDOGLOSS COMPLETE CONTROL		KPE2150A	350 °C SPIDOGLOSS CONTROL BOARD KIT 4PROG	<table border="1"> <thead> <tr> <th>Code</th> <th>Description</th> <th>Qty</th> <th>UOM</th> </tr> </thead> <tbody> <tr> <td>PE2150A0</td> <td>4P 350 °C SPIDOGLOSS COMPLETE CONTROL</td> <td>1.000</td> <td>PC</td> </tr> <tr> <td>V11951A0</td> <td>ZINC PLATED BLACK CROSS SCREW 3,5x16</td> <td>3.000</td> <td>PC</td> </tr> <tr> <td>VM1447A0</td> <td>MM 230x450 PINK ESD AIRBALL BAG</td> <td>0.500</td> <td>PC</td> </tr> <tr> <td>VM2022A0</td> <td>DIGITAL XP WIRING COVE</td> <td>1.000</td> <td>PC</td> </tr> </tbody> </table>	Code	Description	Qty	UOM	PE2150A0	4P 350 °C SPIDOGLOSS COMPLETE CONTROL	1.000	PC	V11951A0	ZINC PLATED BLACK CROSS SCREW 3,5x16	3.000	PC	VM1447A0	MM 230x450 PINK ESD AIRBALL BAG	0.500	PC	VM2022A0	DIGITAL XP WIRING COVE	1.000	PC
Code	Description	Qty	UOM																						
PE2150A0	4P 350 °C SPIDOGLOSS COMPLETE CONTROL	1.000	PC																						
V11951A0	ZINC PLATED BLACK CROSS SCREW 3,5x16	3.000	PC																						
VM1447A0	MM 230x450 PINK ESD AIRBALL BAG	0.500	PC																						
VM2022A0	DIGITAL XP WIRING COVE	1.000	PC																						
VM2022A	DIGITAL XP WIRING COVER		KPE2028A	SPIDOCOOK 4 PROGRAMS CONTROL BOARD KIT	<table border="1"> <thead> <tr> <th>Code</th> <th>Description</th> <th>Qty</th> <th>UOM</th> </tr> </thead> <tbody> <tr> <td>PE2028A0</td> <td>SpidoCook 4 PROGRAMS CONTROL BOARD</td> <td>1.000</td> <td>PC</td> </tr> <tr> <td>V11951A0</td> <td>ZINC PLATED BLACK CROSS SCREW 3,5x16</td> <td>3.000</td> <td>PC</td> </tr> <tr> <td>VM2022A0</td> <td>DIGITAL XP WIRING COVE</td> <td>1.000</td> <td>PC</td> </tr> </tbody> </table>	Code	Description	Qty	UOM	PE2028A0	SpidoCook 4 PROGRAMS CONTROL BOARD	1.000	PC	V11951A0	ZINC PLATED BLACK CROSS SCREW 3,5x16	3.000	PC	VM2022A0	DIGITAL XP WIRING COVE	1.000	PC				
Code	Description	Qty	UOM																						
PE2028A0	SpidoCook 4 PROGRAMS CONTROL BOARD	1.000	PC																						
V11951A0	ZINC PLATED BLACK CROSS SCREW 3,5x16	3.000	PC																						
VM2022A0	DIGITAL XP WIRING COVE	1.000	PC																						

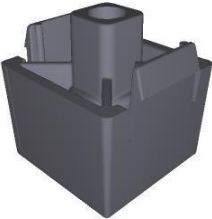
COMPONENT			SPARE PART																																																		
Code	Description	Image	Code	Description	Kit components																																																
VM2022A	DIGITAL XP WIRING COVER		KPE0002A	SBUX XP010ER-SB BOARDS UPGRADE KIT	<table border="1"> <thead> <tr> <th>Code</th> <th>Description</th> <th>Qty</th> <th>UOM</th> </tr> </thead> <tbody> <tr> <td>CE1285A0</td> <td>EMI ROUND FERRITE MOD.26438015 02</td> <td>1.000</td> <td>PC</td> </tr> <tr> <td>CE1725A0</td> <td>ROBOTICS SILICON PIPE 4x0,5 MMQ</td> <td>0.600</td> <td>M</td> </tr> <tr> <td>CE1735A0</td> <td>MINIFIT FEMALE END FITTING</td> <td>8.000</td> <td>PC</td> </tr> <tr> <td>CE1755A0</td> <td>4 WAYS MALE MINIFIT CONNECTOR</td> <td>2.000</td> <td>PC</td> </tr> <tr> <td>PE1645B0</td> <td>12VDC Ø42MM EXTERNAL BUZZER</td> <td>1.000</td> <td>PC</td> </tr> <tr> <td>PE1790C0</td> <td>SpidoCook POWER CARD</td> <td>1.000</td> <td>PC</td> </tr> <tr> <td>PE1986B1</td> <td>SB SPIDOCOOK CONTROL BOARD</td> <td>1.000</td> <td>PC</td> </tr> <tr> <td>VI1951A0</td> <td>ZINC PLATED BLACK CROSS SCREW 3,5x16</td> <td>3.000</td> <td>PC</td> </tr> <tr> <td>VM1447A0</td> <td>MM 230x450 PINK ESD AIRBALL BAG</td> <td>1.000</td> <td>PC</td> </tr> <tr> <td>VM1745A0</td> <td>CARD SUPPORT</td> <td>7.000</td> <td>PC</td> </tr> <tr> <td>VM2022A0</td> <td>DIGITAL XP WIRING COVE</td> <td>1.000</td> <td>PC</td> </tr> </tbody> </table>	Code	Description	Qty	UOM	CE1285A0	EMI ROUND FERRITE MOD.26438015 02	1.000	PC	CE1725A0	ROBOTICS SILICON PIPE 4x0,5 MMQ	0.600	M	CE1735A0	MINIFIT FEMALE END FITTING	8.000	PC	CE1755A0	4 WAYS MALE MINIFIT CONNECTOR	2.000	PC	PE1645B0	12VDC Ø42MM EXTERNAL BUZZER	1.000	PC	PE1790C0	SpidoCook POWER CARD	1.000	PC	PE1986B1	SB SPIDOCOOK CONTROL BOARD	1.000	PC	VI1951A0	ZINC PLATED BLACK CROSS SCREW 3,5x16	3.000	PC	VM1447A0	MM 230x450 PINK ESD AIRBALL BAG	1.000	PC	VM1745A0	CARD SUPPORT	7.000	PC	VM2022A0	DIGITAL XP WIRING COVE	1.000	PC
			Code	Description	Qty	UOM																																															
CE1285A0	EMI ROUND FERRITE MOD.26438015 02	1.000	PC																																																		
CE1725A0	ROBOTICS SILICON PIPE 4x0,5 MMQ	0.600	M																																																		
CE1735A0	MINIFIT FEMALE END FITTING	8.000	PC																																																		
CE1755A0	4 WAYS MALE MINIFIT CONNECTOR	2.000	PC																																																		
PE1645B0	12VDC Ø42MM EXTERNAL BUZZER	1.000	PC																																																		
PE1790C0	SpidoCook POWER CARD	1.000	PC																																																		
PE1986B1	SB SPIDOCOOK CONTROL BOARD	1.000	PC																																																		
VI1951A0	ZINC PLATED BLACK CROSS SCREW 3,5x16	3.000	PC																																																		
VM1447A0	MM 230x450 PINK ESD AIRBALL BAG	1.000	PC																																																		
VM1745A0	CARD SUPPORT	7.000	PC																																																		
VM2022A0	DIGITAL XP WIRING COVE	1.000	PC																																																		
KPE0001A	SPIDOCOOK DIGITAL CARDS REPLACEMENT KIT	<table border="1"> <thead> <tr> <th>Code</th> <th>Description</th> <th>Qty</th> <th>UOM</th> </tr> </thead> <tbody> <tr> <td>CE1285A0</td> <td>EMI ROUND FERRITE MOD.26438015 02</td> <td>1.000</td> <td>PC</td> </tr> <tr> <td>CE1725A0</td> <td>ROBOTICS SILICON PIPE 4x0,5 MMQ</td> <td>0.600</td> <td>M</td> </tr> <tr> <td>CE1735A0</td> <td>MINIFIT FEMALE END FITTING</td> <td>8.000</td> <td>PC</td> </tr> <tr> <td>CE1755A0</td> <td>4 WAYS MALE MINIFIT CONNECTOR</td> <td>2.000</td> <td>PC</td> </tr> <tr> <td>PE1790B0</td> <td>SPIDOCOOK POWER CARD</td> <td>1.000</td> <td>PC</td> </tr> <tr> <td>PE2028A0</td> <td>SpidoCook 4 PROGRAMS CONTROL BOARD</td> <td>1.000</td> <td>PC</td> </tr> </tbody> </table>	Code	Description	Qty	UOM	CE1285A0	EMI ROUND FERRITE MOD.26438015 02	1.000	PC	CE1725A0	ROBOTICS SILICON PIPE 4x0,5 MMQ	0.600	M	CE1735A0	MINIFIT FEMALE END FITTING	8.000	PC	CE1755A0	4 WAYS MALE MINIFIT CONNECTOR	2.000	PC	PE1790B0	SPIDOCOOK POWER CARD	1.000	PC	PE2028A0	SpidoCook 4 PROGRAMS CONTROL BOARD	1.000	PC																							
Code	Description	Qty	UOM																																																		
CE1285A0	EMI ROUND FERRITE MOD.26438015 02	1.000	PC																																																		
CE1725A0	ROBOTICS SILICON PIPE 4x0,5 MMQ	0.600	M																																																		
CE1735A0	MINIFIT FEMALE END FITTING	8.000	PC																																																		
CE1755A0	4 WAYS MALE MINIFIT CONNECTOR	2.000	PC																																																		
PE1790B0	SPIDOCOOK POWER CARD	1.000	PC																																																		
PE2028A0	SpidoCook 4 PROGRAMS CONTROL BOARD	1.000	PC																																																		

COMPONENT			SPARE PART																										
Code	Description	Image	Code	Description	Kit components																								
VM2022A	DIGITAL XP WIRING COVER		KPE0001A	SPIDOCOOK DIGITAL CARDS REPLACEMENT KIT	<table border="1"> <thead> <tr> <th>Code</th> <th>Description</th> <th>Qty</th> <th>UOM</th> </tr> </thead> <tbody> <tr> <td>VI1951A0</td> <td>ZINC PLATED BLACK CROSS SCREW 3,5x16</td> <td>3.000</td> <td>PC</td> </tr> <tr> <td>VM1745A0</td> <td>CARD SUPPORT</td> <td>7.000</td> <td>PC</td> </tr> <tr> <td>VM2022A0</td> <td>DIGITAL XP WIRING COVE</td> <td>1.000</td> <td>PC</td> </tr> </tbody> </table>	Code	Description	Qty	UOM	VI1951A0	ZINC PLATED BLACK CROSS SCREW 3,5x16	3.000	PC	VM1745A0	CARD SUPPORT	7.000	PC	VM2022A0	DIGITAL XP WIRING COVE	1.000	PC								
Code	Description	Qty	UOM																										
VI1951A0	ZINC PLATED BLACK CROSS SCREW 3,5x16	3.000	PC																										
VM1745A0	CARD SUPPORT	7.000	PC																										
VM2022A0	DIGITAL XP WIRING COVE	1.000	PC																										
VE1530A	GOLD THERMOMETER BLUE LIGHT COVER		KLP1012A	GOLDEN THERMOMETER BLUE LIGHT KIT	<table border="1"> <thead> <tr> <th>Code</th> <th>Description</th> <th>Qty</th> <th>UOM</th> </tr> </thead> <tbody> <tr> <td>VE1170A0</td> <td>D16 OPAQUE NICKEL ELLIPTICAL SUPPORT</td> <td>1.000</td> <td>PC</td> </tr> <tr> <td>VE1530A0</td> <td>GOLD THERMOMETE R BLUE LIGHT COVER</td> <td>1.000</td> <td>PC</td> </tr> <tr> <td>VE1535A1</td> <td>230V WHITE LED</td> <td>1.000</td> <td>PC</td> </tr> <tr> <td>VM1762A0</td> <td>INNER LAMP SUPPORT</td> <td>1.000</td> <td>PC</td> </tr> <tr> <td>VM2009A0</td> <td>D16 SILVER ELLIPTICAL SUPPORT</td> <td>1.000</td> <td>PC</td> </tr> </tbody> </table>	Code	Description	Qty	UOM	VE1170A0	D16 OPAQUE NICKEL ELLIPTICAL SUPPORT	1.000	PC	VE1530A0	GOLD THERMOMETE R BLUE LIGHT COVER	1.000	PC	VE1535A1	230V WHITE LED	1.000	PC	VM1762A0	INNER LAMP SUPPORT	1.000	PC	VM2009A0	D16 SILVER ELLIPTICAL SUPPORT	1.000	PC
Code	Description	Qty	UOM																										
VE1170A0	D16 OPAQUE NICKEL ELLIPTICAL SUPPORT	1.000	PC																										
VE1530A0	GOLD THERMOMETE R BLUE LIGHT COVER	1.000	PC																										
VE1535A1	230V WHITE LED	1.000	PC																										
VM1762A0	INNER LAMP SUPPORT	1.000	PC																										
VM2009A0	D16 SILVER ELLIPTICAL SUPPORT	1.000	PC																										
VE1545A	12V WHITE LED LIGHT		KVE1545A	12V WHITE LED 10 PCS. KIT	<table border="1"> <thead> <tr> <th>Code</th> <th>Description</th> <th>Qty</th> <th>UOM</th> </tr> </thead> <tbody> <tr> <td>VE1545A0</td> <td>12V WHITE LED LIGHT</td> <td>10.000</td> <td>PC</td> </tr> </tbody> </table>	Code	Description	Qty	UOM	VE1545A0	12V WHITE LED LIGHT	10.000	PC																
Code	Description	Qty	UOM																										
VE1545A0	12V WHITE LED LIGHT	10.000	PC																										
VM1762A	INNER LAMP SUPPORT		KVM1762A	LAMP INTERNAL SUPPORT KIT	<table border="1"> <thead> <tr> <th>Code</th> <th>Description</th> <th>Qty</th> <th>UOM</th> </tr> </thead> <tbody> <tr> <td>VM1762A0</td> <td>INNER LAMP SUPPORT</td> <td>1.000</td> <td>PC</td> </tr> </tbody> </table>	Code	Description	Qty	UOM	VM1762A0	INNER LAMP SUPPORT	1.000	PC																
Code	Description	Qty	UOM																										
VM1762A0	INNER LAMP SUPPORT	1.000	PC																										

COMPONENT			SPARE PART										
Code	Description	Image	Code	Description	Kit components								
MR1000A	CABLE 3x1,5 H07RN-F MT1,5+K2/3+SCHUK		KMR1000A	KIT CABLE 3X1,5 H07RN-F +K2/3+SCHUKO	<table border="1"> <thead> <tr> <th>Code</th> <th>Description</th> <th>Qty</th> <th>UOM</th> </tr> </thead> <tbody> <tr> <td>MR1000A0</td> <td>CABLE 3x1,5 H07RN-F MT1,5+K2/3+S CHUKO</td> <td>1.000</td> <td>PC</td> </tr> </tbody> </table>	Code	Description	Qty	UOM	MR1000A0	CABLE 3x1,5 H07RN-F MT1,5+K2/3+S CHUKO	1.000	PC
Code	Description	Qty	UOM										
MR1000A0	CABLE 3x1,5 H07RN-F MT1,5+K2/3+S CHUKO	1.000	PC										
PD1001A	35x35 H26 GREY PLASTIC+RUBBER FOOT		KPD1001A	35x35 H26 FEET 4 PCS KIT	<table border="1"> <thead> <tr> <th>Code</th> <th>Description</th> <th>Qty</th> <th>UOM</th> </tr> </thead> <tbody> <tr> <td>PD1001A0</td> <td>35x35 H26 GREY PLASTIC+RUB BER FOOT</td> <td>4.000</td> <td>PC</td> </tr> </tbody> </table>	Code	Description	Qty	UOM	PD1001A0	35x35 H26 GREY PLASTIC+RUB BER FOOT	4.000	PC
Code	Description	Qty	UOM										
PD1001A0	35x35 H26 GREY PLASTIC+RUB BER FOOT	4.000	PC										
VM1315A	XP FAT DRAIN		KVM1315A	XP FAT DRAIN KIT VM1315A	<table border="1"> <thead> <tr> <th>Code</th> <th>Description</th> <th>Qty</th> <th>UOM</th> </tr> </thead> <tbody> <tr> <td>VM1315A0</td> <td>XP FAT DRAIN</td> <td>1.000</td> <td>PC</td> </tr> </tbody> </table>	Code	Description	Qty	UOM	VM1315A0	XP FAT DRAIN	1.000	PC
Code	Description	Qty	UOM										
VM1315A0	XP FAT DRAIN	1.000	PC										
VM1545A	CONTACT GRILL DRIP TRAY		KVM1545A	DRIP TRAY FOR XP CONTACT GRILL KIT	<table border="1"> <thead> <tr> <th>Code</th> <th>Description</th> <th>Qty</th> <th>UOM</th> </tr> </thead> <tbody> <tr> <td>VM1545A1</td> <td>CONTACT GRILL DRIP TRAY</td> <td>1.000</td> <td>PC</td> </tr> </tbody> </table>	Code	Description	Qty	UOM	VM1545A1	CONTACT GRILL DRIP TRAY	1.000	PC
Code	Description	Qty	UOM										
VM1545A1	CONTACT GRILL DRIP TRAY	1.000	PC										
VM1546A	CONTACT GRILL DRIP TRAY GUIDE		KVM1546A	DIP TRAY GUIDE KIT	<table border="1"> <thead> <tr> <th>Code</th> <th>Description</th> <th>Qty</th> <th>UOM</th> </tr> </thead> <tbody> <tr> <td>VM1546A0</td> <td>CONTACT GRILL DRIP TRAY GUIDE</td> <td>1.000</td> <td>PC</td> </tr> </tbody> </table>	Code	Description	Qty	UOM	VM1546A0	CONTACT GRILL DRIP TRAY GUIDE	1.000	PC
Code	Description	Qty	UOM										
VM1546A0	CONTACT GRILL DRIP TRAY GUIDE	1.000	PC										

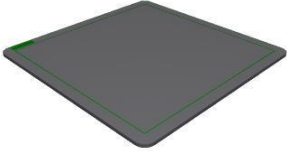

COMPONENT			SPARE PART															
Code	Description	Image	Code	Description	Kit components													
VT1225A	250X250x4 SMOOTH BLACK GLASSCERAMIC		KVT1385AB	SMOOTH BLACK SINGLE LOWER GLASS CER KIT	<table border="1"> <thead> <tr> <th>Code</th> <th>Description</th> <th>Qty</th> <th>UOM</th> </tr> </thead> <tbody> <tr> <td>SL1045A0</td> <td>S57 BLACK SILICONE - 80ml CARTRIDGE</td> <td>1.000</td> <td>PC</td> </tr> <tr> <td>VT1385A0</td> <td>250x250 SMOOTH BLACK GLASS CERAMIC</td> <td>1.000</td> <td>PC</td> </tr> </tbody> </table>	Code	Description	Qty	UOM	SL1045A0	S57 BLACK SILICONE - 80ml CARTRIDGE	1.000	PC	VT1385A0	250x250 SMOOTH BLACK GLASS CERAMIC	1.000	PC	
			Code	Description	Qty	UOM												
SL1045A0	S57 BLACK SILICONE - 80ml CARTRIDGE	1.000	PC															
VT1385A0	250x250 SMOOTH BLACK GLASS CERAMIC	1.000	PC															
KVT1385A	SMOOTH BLACK SINGLE UPPER GLASS CER KIT	<table border="1"> <thead> <tr> <th>Code</th> <th>Description</th> <th>Qty</th> <th>UOM</th> </tr> </thead> <tbody> <tr> <td>OD2011A1</td> <td>XP UPPER GLASS FRAME</td> <td>1.000</td> <td>PC</td> </tr> <tr> <td>SL1170A1</td> <td>S57 BLACK SILICON - 310ml CARTRIDGE</td> <td>0.010</td> <td>ML</td> </tr> <tr> <td>VT1385A0</td> <td>250x250 SMOOTH BLACK GLASS CERAMIC</td> <td>1.000</td> <td>PC</td> </tr> </tbody> </table>	Code	Description	Qty	UOM	OD2011A1	XP UPPER GLASS FRAME	1.000	PC	SL1170A1	S57 BLACK SILICON - 310ml CARTRIDGE	0.010	ML	VT1385A0	250x250 SMOOTH BLACK GLASS CERAMIC	1.000	PC
Code	Description	Qty	UOM															
OD2011A1	XP UPPER GLASS FRAME	1.000	PC															
SL1170A1	S57 BLACK SILICON - 310ml CARTRIDGE	0.010	ML															
VT1385A0	250x250 SMOOTH BLACK GLASS CERAMIC	1.000	PC															

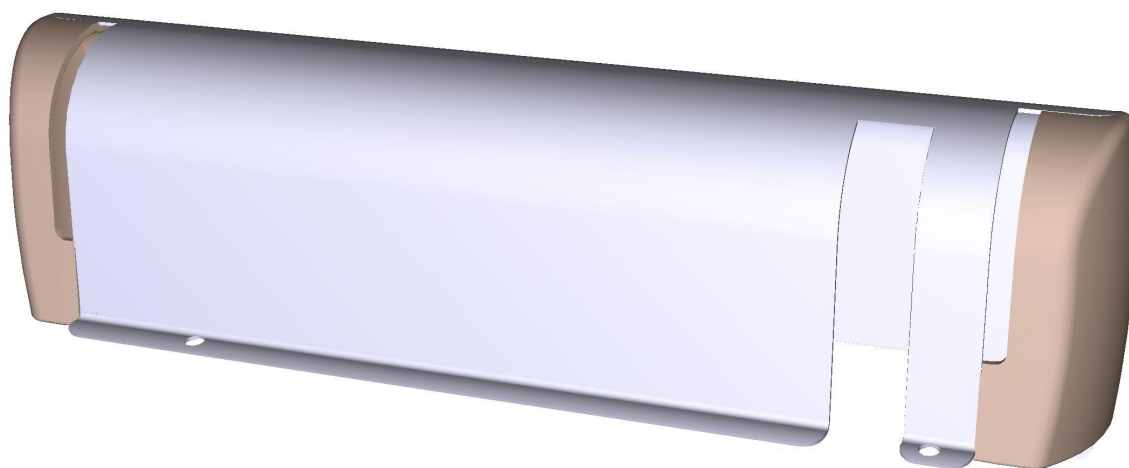
ASM0095A/0.D00 - General overview - FRONT



ASM0095A/0.D00 - General overview - REAR

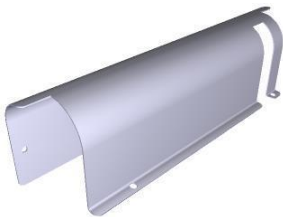

COMPONENT			SPARE PART										
Code	Description	Image	Code	Description	Kit components								
0D1985A	SINGLE CASE MECHANISM COVER XP		0D1985A0	SINGLE CASE MECHANISM COVER XP									
VM1550A	SP GRILL MECHANISM COVER RIGHT CAP		KVM1550A	CONT GRILL MECHANISM COVER RIGHT CAP KIT	<table border="1"> <thead> <tr> <th>Code</th> <th>Description</th> <th>Qty</th> <th>UOM</th> </tr> </thead> <tbody> <tr> <td>VM1550A1</td> <td>SP GRILL MECHANISM COVER RIGHT CAP</td> <td>1.000</td> <td>PC</td> </tr> </tbody> </table>	Code	Description	Qty	UOM	VM1550A1	SP GRILL MECHANISM COVER RIGHT CAP	1.000	PC
Code	Description	Qty	UOM										
VM1550A1	SP GRILL MECHANISM COVER RIGHT CAP	1.000	PC										
VM1551A	CONTACT GRILL LEFT MECHANISM COVER CAP		KVM1551A	SP GRILL MECHAN.COVER LEFT CAP KIT	<table border="1"> <thead> <tr> <th>Code</th> <th>Description</th> <th>Qty</th> <th>UOM</th> </tr> </thead> <tbody> <tr> <td>VM1551A1</td> <td>CONTACT GRILL LEFT MECHANISM COVER CAP</td> <td>1.000</td> <td>PC</td> </tr> </tbody> </table>	Code	Description	Qty	UOM	VM1551A1	CONTACT GRILL LEFT MECHANISM COVER CAP	1.000	PC
Code	Description	Qty	UOM										
VM1551A1	CONTACT GRILL LEFT MECHANISM COVER CAP	1.000	PC										