









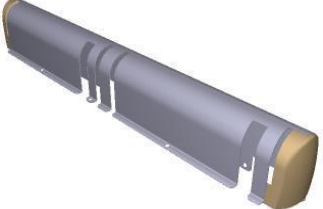
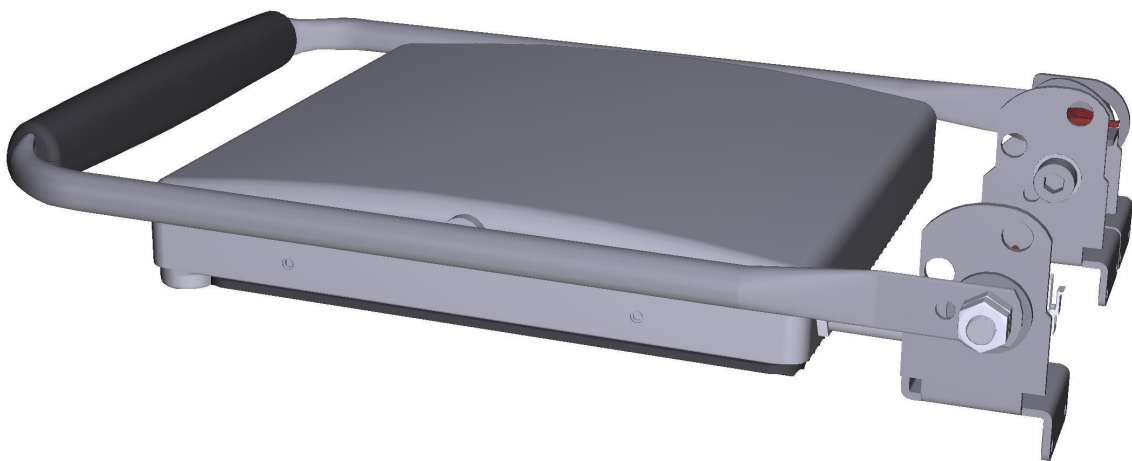
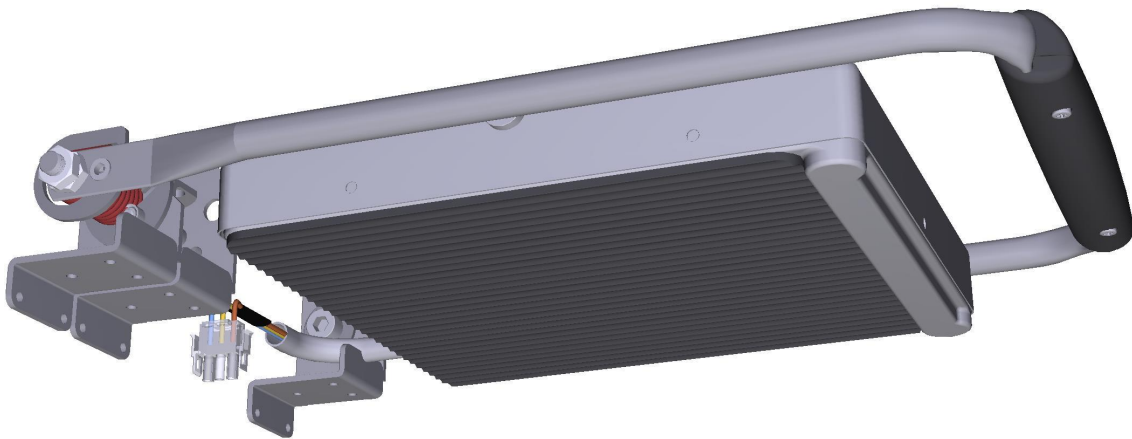
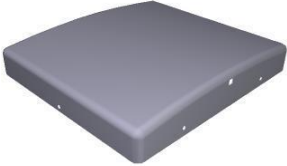

Assembly code	Assembly description	Assembly image
ASM0090A/0.D06	General overview	
ASM0092C/0.D02	General overview	
ASM0096A/0.D00	General overview	



ASM0090A/0.D06 - General overview - FRONT

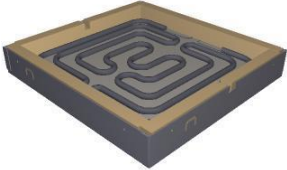

ASM0090A/0.D06 - General overview - REAR



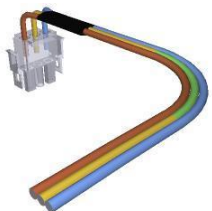

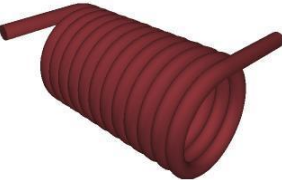
COMPONENT			SPARE PART																		
Code	Description	Image	Code	Description	Kit components																
0D2010A	UPPER CASE HEATING ELEMENT XP		0D2010A0	UPPER CASE HEATING ELEMENT XP																	
0D2011A	XP UPPER GLASS FRAME		KVT1225A	Upper Black Smooth Single Glass CER. Kit	<table border="1"> <thead> <tr> <th>Code</th> <th>Description</th> <th>Qty</th> <th>UOM</th> </tr> </thead> <tbody> <tr> <td>0D2011A1</td> <td>XP UPPER GLASS FRAME</td> <td>1.000</td> <td>PC</td> </tr> <tr> <td>SL1171A1</td> <td>SILICON ANTHRACITE S57 BARREL</td> <td>0.010</td> <td>ML</td> </tr> <tr> <td>VT1225A0</td> <td>250X250x4 SMOOTH BLACK GLASSCERAM IC</td> <td>1.000</td> <td>PC</td> </tr> </tbody> </table>	Code	Description	Qty	UOM	0D2011A1	XP UPPER GLASS FRAME	1.000	PC	SL1171A1	SILICON ANTHRACITE S57 BARREL	0.010	ML	VT1225A0	250X250x4 SMOOTH BLACK GLASSCERAM IC	1.000	PC
Code	Description	Qty	UOM																		
0D2011A1	XP UPPER GLASS FRAME	1.000	PC																		
SL1171A1	SILICON ANTHRACITE S57 BARREL	0.010	ML																		
VT1225A0	250X250x4 SMOOTH BLACK GLASSCERAM IC	1.000	PC																		
0H2517A	BRACKET SIDE SPRINGS SEAT		0H2517A0	BRACKET SIDE SPRINGS SEAT																	
0H2518A	HANDLE SIDE SPRINGS SEAT		0H2518A0	HANDLE SIDE SPRINGS SEAT																	
0H4815A	XP CONTACT GRILL LEFT HANDLE BRACKET		0H4815A0	XP CONTACT GRILL LEFT HANDLE BRACKET																	

COMPONENT			SPARE PART																																																		
Code	Description	Image	Code	Description	Kit components																																																
0H4816A	XP CONTACT GRILL RIGHT HANDLE BRACKET		K0H4816A	XP RIGHT HANDLE BRACKET KIT	<table border="1"> <thead> <tr> <th>Code</th> <th>Description</th> <th>Qty</th> <th>UOM</th> </tr> </thead> <tbody> <tr> <td>0H4816A0</td> <td>XP CONTACT GRILL RIGHT HANDLE BRACKET</td> <td>1.000</td> <td>PC</td> </tr> <tr> <td>V11605A0</td> <td>BUSHINGS M5 FTT-C-TC KNURLED</td> <td>1.000</td> <td>PC</td> </tr> </tbody> </table>	Code	Description	Qty	UOM	0H4816A0	XP CONTACT GRILL RIGHT HANDLE BRACKET	1.000	PC	V11605A0	BUSHINGS M5 FTT-C-TC KNURLED	1.000	PC																																				
					Code	Description	Qty	UOM																																													
0H4816A0	XP CONTACT GRILL RIGHT HANDLE BRACKET	1.000	PC																																																		
V11605A0	BUSHINGS M5 FTT-C-TC KNURLED	1.000	PC																																																		
<table border="1"> <thead> <tr> <th>Code</th> <th>Description</th> <th>Qty</th> <th>UOM</th> </tr> </thead> <tbody> <tr> <td>RS1258A0</td> <td>750W 230V GLASS CERAMIC HEATING ELEMENT</td> <td>1.000</td> <td>PC</td> </tr> <tr> <td>RS1259A0</td> <td>XP BULB HOLDER PLATE L224 7.5x0.4</td> <td>1.000</td> <td>PC</td> </tr> </tbody> </table>	Code	Description	Qty	UOM	RS1258A0	750W 230V GLASS CERAMIC HEATING ELEMENT	1.000	PC	RS1259A0	XP BULB HOLDER PLATE L224 7.5x0.4	1.000	PC																																									
Code	Description	Qty	UOM																																																		
RS1258A0	750W 230V GLASS CERAMIC HEATING ELEMENT	1.000	PC																																																		
RS1259A0	XP BULB HOLDER PLATE L224 7.5x0.4	1.000	PC																																																		
RS1258A	750W 230V GLASS CERAMIC HEATING ELEMENT		KRS1258A	750W 230V GLASS CER.HEATING EL.KI	<table border="1"> <thead> <tr> <th>Code</th> <th>Description</th> <th>Qty</th> <th>UOM</th> </tr> </thead> <tbody> <tr> <td>RS1258A0</td> <td>750W 230V GLASS CERAMIC HEATING ELEMENT</td> <td>1.000</td> <td>PC</td> </tr> <tr> <td>RS1259A0</td> <td>XP BULB HOLDER PLATE L224 7.5x0.4</td> <td>1.000</td> <td>PC</td> </tr> </tbody> </table>	Code	Description	Qty	UOM	RS1258A0	750W 230V GLASS CERAMIC HEATING ELEMENT	1.000	PC	RS1259A0	XP BULB HOLDER PLATE L224 7.5x0.4	1.000	PC																																				
Code	Description	Qty	UOM																																																		
RS1258A0	750W 230V GLASS CERAMIC HEATING ELEMENT	1.000	PC																																																		
RS1259A0	XP BULB HOLDER PLATE L224 7.5x0.4	1.000	PC																																																		
GN1322A	EXT Ø 27 INT Ø 10 GASKET		KML1020A	XP-SP SPIDO ML1000A SPRINGS KIT	<table border="1"> <thead> <tr> <th>Code</th> <th>Description</th> <th>Qty</th> <th>UOM</th> </tr> </thead> <tbody> <tr> <td>0H2517A0</td> <td>BRACKET SIDE SPRINGS SEAT</td> <td>1.000</td> <td>PC</td> </tr> <tr> <td>0H2518A0</td> <td>HANDLE SIDE SPRINGS SEA</td> <td>1.000</td> <td>PC</td> </tr> <tr> <td>GN1322A0</td> <td>EXT Ø 27 INT Ø 10 GASKET</td> <td>2.000</td> <td>PC</td> </tr> <tr> <td>ML1000A1</td> <td>De24.4 H44 12 TURNS TORSION SPRING</td> <td>2.000</td> <td>PC</td> </tr> <tr> <td>V11047A0</td> <td>SCREW M5x10 TSP+ ZINC.TO THICKNE.12</td> <td>2.000</td> <td>PC</td> </tr> <tr> <td>V11093A0</td> <td>M10X30 TCEI 12.9 UNI5931 SCREW</td> <td>1.000</td> <td>PC</td> </tr> <tr> <td>V11096A0</td> <td>M10x110 TCEI SCREW</td> <td>1.000</td> <td>PC</td> </tr> <tr> <td>V11303A0</td> <td>M10 H6 ZN LOW NUT</td> <td>4.000</td> <td>PC</td> </tr> <tr> <td>V11451A0</td> <td>10X20X0.5 BRASS NICKEL FLAT WASHER</td> <td>1.000</td> <td>PC</td> </tr> <tr> <td>V11528A0</td> <td>10X30X2 ZN FLAT WASHER</td> <td>2.000</td> <td>PC</td> </tr> <tr> <td>VM1512A0</td> <td>SPIDO.COOK SPRING FIXING RING</td> <td>2.000</td> <td>PC</td> </tr> </tbody> </table>	Code	Description	Qty	UOM	0H2517A0	BRACKET SIDE SPRINGS SEAT	1.000	PC	0H2518A0	HANDLE SIDE SPRINGS SEA	1.000	PC	GN1322A0	EXT Ø 27 INT Ø 10 GASKET	2.000	PC	ML1000A1	De24.4 H44 12 TURNS TORSION SPRING	2.000	PC	V11047A0	SCREW M5x10 TSP+ ZINC.TO THICKNE.12	2.000	PC	V11093A0	M10X30 TCEI 12.9 UNI5931 SCREW	1.000	PC	V11096A0	M10x110 TCEI SCREW	1.000	PC	V11303A0	M10 H6 ZN LOW NUT	4.000	PC	V11451A0	10X20X0.5 BRASS NICKEL FLAT WASHER	1.000	PC	V11528A0	10X30X2 ZN FLAT WASHER	2.000	PC	VM1512A0	SPIDO.COOK SPRING FIXING RING	2.000	PC
Code	Description	Qty	UOM																																																		
0H2517A0	BRACKET SIDE SPRINGS SEAT	1.000	PC																																																		
0H2518A0	HANDLE SIDE SPRINGS SEA	1.000	PC																																																		
GN1322A0	EXT Ø 27 INT Ø 10 GASKET	2.000	PC																																																		
ML1000A1	De24.4 H44 12 TURNS TORSION SPRING	2.000	PC																																																		
V11047A0	SCREW M5x10 TSP+ ZINC.TO THICKNE.12	2.000	PC																																																		
V11093A0	M10X30 TCEI 12.9 UNI5931 SCREW	1.000	PC																																																		
V11096A0	M10x110 TCEI SCREW	1.000	PC																																																		
V11303A0	M10 H6 ZN LOW NUT	4.000	PC																																																		
V11451A0	10X20X0.5 BRASS NICKEL FLAT WASHER	1.000	PC																																																		
V11528A0	10X30X2 ZN FLAT WASHER	2.000	PC																																																		
VM1512A0	SPIDO.COOK SPRING FIXING RING	2.000	PC																																																		

COMPONENT			SPARE PART																																																														
Code	Description	Image	Code	Description	Kit components																																																												
GN1322A	EXT Ø 27 INT Ø 10 GASKET		KML0039A	XP SPRING RETROFIT KIT	<table border="1"> <thead> <tr> <th>Code</th> <th>Description</th> <th>Qty</th> <th>UOM</th> </tr> </thead> <tbody> <tr> <td>0H0159A0</td> <td>CONTACT GRILL HANDLE SUPPORT DOUBLE</td> <td>1.000</td> <td>PC</td> </tr> <tr> <td>0H2517A0</td> <td>BRACKET SIDE SPRINGS SEAT</td> <td>1.000</td> <td>PC</td> </tr> <tr> <td>0H2518A0</td> <td>HANDLE SIDE SPRINGS SEA</td> <td>1.000</td> <td>PC</td> </tr> <tr> <td>0H4816A0</td> <td>XP CONTACT GRILL RIGHT HANDLE BRACKET</td> <td>1.000</td> <td>PC</td> </tr> <tr> <td>GN1322A0</td> <td>EXT Ø 27 INT Ø 10 GASKET</td> <td>2.000</td> <td>PC</td> </tr> <tr> <td>ML1000A1</td> <td>De24.4 H44 12 TURNS TORSION SPRING</td> <td>1.000</td> <td>PC</td> </tr> <tr> <td>VI1047A0</td> <td>SCREW M5x10 TSP+ ZINC.TO THICKNE.12</td> <td>1.000</td> <td>PC</td> </tr> <tr> <td>VI1093A0</td> <td>M10X30 TCEI 12.9 UNI5931 SCREW</td> <td>1.000</td> <td>PC</td> </tr> <tr> <td>VI1096A0</td> <td>M10x110 TCEI SCREW</td> <td>1.000</td> <td>PC</td> </tr> <tr> <td>VI1303A0</td> <td>M10 H6 ZN LOW NUT</td> <td>4.000</td> <td>PC</td> </tr> <tr> <td>VI1451A0</td> <td>10X20X0.5 BRASS NICKEL FLAT WASHER</td> <td>1.000</td> <td>PC</td> </tr> <tr> <td>VI1528A0</td> <td>10X30X2 ZN FLAT WASHER</td> <td>2.000</td> <td>PC</td> </tr> <tr> <td>VI1605A0</td> <td>BUSHINGS M5 FTT-C-TC KNURLED</td> <td>1.000</td> <td>PC</td> </tr> <tr> <td>VM1512A0</td> <td>SPIDO.COOK SPRING FIXING RING</td> <td>1.000</td> <td>PC</td> </tr> </tbody> </table>	Code	Description	Qty	UOM	0H0159A0	CONTACT GRILL HANDLE SUPPORT DOUBLE	1.000	PC	0H2517A0	BRACKET SIDE SPRINGS SEAT	1.000	PC	0H2518A0	HANDLE SIDE SPRINGS SEA	1.000	PC	0H4816A0	XP CONTACT GRILL RIGHT HANDLE BRACKET	1.000	PC	GN1322A0	EXT Ø 27 INT Ø 10 GASKET	2.000	PC	ML1000A1	De24.4 H44 12 TURNS TORSION SPRING	1.000	PC	VI1047A0	SCREW M5x10 TSP+ ZINC.TO THICKNE.12	1.000	PC	VI1093A0	M10X30 TCEI 12.9 UNI5931 SCREW	1.000	PC	VI1096A0	M10x110 TCEI SCREW	1.000	PC	VI1303A0	M10 H6 ZN LOW NUT	4.000	PC	VI1451A0	10X20X0.5 BRASS NICKEL FLAT WASHER	1.000	PC	VI1528A0	10X30X2 ZN FLAT WASHER	2.000	PC	VI1605A0	BUSHINGS M5 FTT-C-TC KNURLED	1.000	PC	VM1512A0	SPIDO.COOK SPRING FIXING RING	1.000	PC
Code	Description	Qty	UOM																																																														
0H0159A0	CONTACT GRILL HANDLE SUPPORT DOUBLE	1.000	PC																																																														
0H2517A0	BRACKET SIDE SPRINGS SEAT	1.000	PC																																																														
0H2518A0	HANDLE SIDE SPRINGS SEA	1.000	PC																																																														
0H4816A0	XP CONTACT GRILL RIGHT HANDLE BRACKET	1.000	PC																																																														
GN1322A0	EXT Ø 27 INT Ø 10 GASKET	2.000	PC																																																														
ML1000A1	De24.4 H44 12 TURNS TORSION SPRING	1.000	PC																																																														
VI1047A0	SCREW M5x10 TSP+ ZINC.TO THICKNE.12	1.000	PC																																																														
VI1093A0	M10X30 TCEI 12.9 UNI5931 SCREW	1.000	PC																																																														
VI1096A0	M10x110 TCEI SCREW	1.000	PC																																																														
VI1303A0	M10 H6 ZN LOW NUT	4.000	PC																																																														
VI1451A0	10X20X0.5 BRASS NICKEL FLAT WASHER	1.000	PC																																																														
VI1528A0	10X30X2 ZN FLAT WASHER	2.000	PC																																																														
VI1605A0	BUSHINGS M5 FTT-C-TC KNURLED	1.000	PC																																																														
VM1512A0	SPIDO.COOK SPRING FIXING RING	1.000	PC																																																														
			KG1322A	GASKET KIT DE27 DI10 SP2	<table border="1"> <thead> <tr> <th>Code</th> <th>Description</th> <th>Qty</th> <th>UOM</th> </tr> </thead> <tbody> <tr> <td>GN1322A0</td> <td>EXT Ø 27 INT Ø 10 GASKET</td> <td>2.000</td> <td>PC</td> </tr> </tbody> </table>	Code	Description	Qty	UOM	GN1322A0	EXT Ø 27 INT Ø 10 GASKET	2.000	PC																																																				
Code	Description	Qty	UOM																																																														
GN1322A0	EXT Ø 27 INT Ø 10 GASKET	2.000	PC																																																														

COMPONENT			SPARE PART																																						
Code	Description	Image	Code	Description	Kit components																																				
IE1530A	UPPER HEATING ELEMENTS KIT SERIE XAP		KIE1530A	XAP SAP UPPER HEATING ELEMENT KIT	<table border="1"> <thead> <tr> <th>Code</th> <th>Description</th> <th>Qty</th> <th>UOM</th> </tr> </thead> <tbody> <tr> <td>GN1095A0</td> <td>Ø14 - L=30 NEOPRENE SLEEVE</td> <td>1.000</td> <td>PC</td> </tr> <tr> <td>IE1530A0</td> <td>UPPER HEATING ELEMENTS KIT SERIE XAP</td> <td>1.000</td> <td>PC</td> </tr> </tbody> </table>	Code	Description	Qty	UOM	GN1095A0	Ø14 - L=30 NEOPRENE SLEEVE	1.000	PC	IE1530A0	UPPER HEATING ELEMENTS KIT SERIE XAP	1.000	PC																								
Code	Description	Qty	UOM																																						
GN1095A0	Ø14 - L=30 NEOPRENE SLEEVE	1.000	PC																																						
IE1530A0	UPPER HEATING ELEMENTS KIT SERIE XAP	1.000	PC																																						
MG1040A	CLAMPSHELL GRILL UPPER HANDLE		KMG1040A	CLAMPSHELL GRILL HANDLE KIT	<table border="1"> <thead> <tr> <th>Code</th> <th>Description</th> <th>Qty</th> <th>UOM</th> </tr> </thead> <tbody> <tr> <td>MG1040A1</td> <td>CLAMPSHELL GRILL UPPER HANDLE</td> <td>1.000</td> <td>PC</td> </tr> <tr> <td>MG1041A0</td> <td>XP SERIES LOWER HANDLE</td> <td>1.000</td> <td>PC</td> </tr> <tr> <td>VI1955A0</td> <td>ST STEEL CROSS SCREW 4x20</td> <td>2.000</td> <td>PC</td> </tr> </tbody> </table>	Code	Description	Qty	UOM	MG1040A1	CLAMPSHELL GRILL UPPER HANDLE	1.000	PC	MG1041A0	XP SERIES LOWER HANDLE	1.000	PC	VI1955A0	ST STEEL CROSS SCREW 4x20	2.000	PC																				
Code	Description	Qty	UOM																																						
MG1040A1	CLAMPSHELL GRILL UPPER HANDLE	1.000	PC																																						
MG1041A0	XP SERIES LOWER HANDLE	1.000	PC																																						
VI1955A0	ST STEEL CROSS SCREW 4x20	2.000	PC																																						
MG1041A	XP SERIES LOWER HANDLE		KMG1040A	CLAMPSHELL GRILL HANDLE KIT	<table border="1"> <thead> <tr> <th>Code</th> <th>Description</th> <th>Qty</th> <th>UOM</th> </tr> </thead> <tbody> <tr> <td>MG1040A1</td> <td>CLAMPSHELL GRILL UPPER HANDLE</td> <td>1.000</td> <td>PC</td> </tr> <tr> <td>MG1041A0</td> <td>XP SERIES LOWER HANDLE</td> <td>1.000</td> <td>PC</td> </tr> <tr> <td>VI1955A0</td> <td>ST STEEL CROSS SCREW 4x20</td> <td>2.000</td> <td>PC</td> </tr> </tbody> </table>	Code	Description	Qty	UOM	MG1040A1	CLAMPSHELL GRILL UPPER HANDLE	1.000	PC	MG1041A0	XP SERIES LOWER HANDLE	1.000	PC	VI1955A0	ST STEEL CROSS SCREW 4x20	2.000	PC																				
Code	Description	Qty	UOM																																						
MG1040A1	CLAMPSHELL GRILL UPPER HANDLE	1.000	PC																																						
MG1041A0	XP SERIES LOWER HANDLE	1.000	PC																																						
VI1955A0	ST STEEL CROSS SCREW 4x20	2.000	PC																																						
ML1000A	De24.4 H44 12 TURNS TORSION SPRING		KML1020A	XP-SP SPIDO ML1000A SPRINGS KIT	<table border="1"> <thead> <tr> <th>Code</th> <th>Description</th> <th>Qty</th> <th>UOM</th> </tr> </thead> <tbody> <tr> <td>0H2517A0</td> <td>BRACKET SIDE SPRINGS SEAT</td> <td>1.000</td> <td>PC</td> </tr> <tr> <td>0H2518A0</td> <td>HANDLE SIDE SPRINGS SEA</td> <td>1.000</td> <td>PC</td> </tr> <tr> <td>GN1322A0</td> <td>EXT Ø 27 INT Ø 10 GASKET</td> <td>2.000</td> <td>PC</td> </tr> <tr> <td>ML1000A1</td> <td>De24.4 H44 12 TURNS TORSION SPRING</td> <td>2.000</td> <td>PC</td> </tr> <tr> <td>VI1047A0</td> <td>SCREW M5x10 TSP+ ZINC.TO THICKNE.12</td> <td>2.000</td> <td>PC</td> </tr> <tr> <td>VI1093A0</td> <td>M10X30 TCEI 12.9 UNI5931 SCREW</td> <td>1.000</td> <td>PC</td> </tr> <tr> <td>VI1096A0</td> <td>M10x110 TCEI SCREW</td> <td>1.000</td> <td>PC</td> </tr> <tr> <td>VI1303A0</td> <td>M10 H6 ZN LOW NUT</td> <td>4.000</td> <td>PC</td> </tr> </tbody> </table>	Code	Description	Qty	UOM	0H2517A0	BRACKET SIDE SPRINGS SEAT	1.000	PC	0H2518A0	HANDLE SIDE SPRINGS SEA	1.000	PC	GN1322A0	EXT Ø 27 INT Ø 10 GASKET	2.000	PC	ML1000A1	De24.4 H44 12 TURNS TORSION SPRING	2.000	PC	VI1047A0	SCREW M5x10 TSP+ ZINC.TO THICKNE.12	2.000	PC	VI1093A0	M10X30 TCEI 12.9 UNI5931 SCREW	1.000	PC	VI1096A0	M10x110 TCEI SCREW	1.000	PC	VI1303A0	M10 H6 ZN LOW NUT	4.000	PC
Code	Description	Qty	UOM																																						
0H2517A0	BRACKET SIDE SPRINGS SEAT	1.000	PC																																						
0H2518A0	HANDLE SIDE SPRINGS SEA	1.000	PC																																						
GN1322A0	EXT Ø 27 INT Ø 10 GASKET	2.000	PC																																						
ML1000A1	De24.4 H44 12 TURNS TORSION SPRING	2.000	PC																																						
VI1047A0	SCREW M5x10 TSP+ ZINC.TO THICKNE.12	2.000	PC																																						
VI1093A0	M10X30 TCEI 12.9 UNI5931 SCREW	1.000	PC																																						
VI1096A0	M10x110 TCEI SCREW	1.000	PC																																						
VI1303A0	M10 H6 ZN LOW NUT	4.000	PC																																						

COMPONENT			SPARE PART																																																		
Code	Description	Image	Code	Description	Kit components																																																
ML1000A	De24.4 H44 12 TURNS TORSION SPRING		KML1020A	XP-SP SPIDO ML1000A SPRINGS KIT	<table border="1"> <thead> <tr> <th>Code</th> <th>Description</th> <th>Qty</th> <th>UOM</th> </tr> </thead> <tbody> <tr> <td>V11451A0</td> <td>10X20X0.5 BRASS NICKEL FLAT WASHER</td> <td>1.000</td> <td>PC</td> </tr> <tr> <td>V11528A0</td> <td>10X30X2 ZN FLAT WASHER</td> <td>2.000</td> <td>PC</td> </tr> <tr> <td>VM1512A0</td> <td>SPIDO.COOK SPRING FIXING RING</td> <td>2.000</td> <td>PC</td> </tr> </tbody> </table>	Code	Description	Qty	UOM	V11451A0	10X20X0.5 BRASS NICKEL FLAT WASHER	1.000	PC	V11528A0	10X30X2 ZN FLAT WASHER	2.000	PC	VM1512A0	SPIDO.COOK SPRING FIXING RING	2.000	PC																																
Code	Description	Qty	UOM																																																		
V11451A0	10X20X0.5 BRASS NICKEL FLAT WASHER	1.000	PC																																																		
V11528A0	10X30X2 ZN FLAT WASHER	2.000	PC																																																		
VM1512A0	SPIDO.COOK SPRING FIXING RING	2.000	PC																																																		
TB1505A	STAINLESS STEEL BENDED TUBE D13		KTB1505A	WIRES GUIDE TUBE KIT	<table border="1"> <thead> <tr> <th>Code</th> <th>Description</th> <th>Qty</th> <th>UOM</th> </tr> </thead> <tbody> <tr> <td>CE1155A0</td> <td>6,3x0,81 - 2,5 ALPACA FEMALE FASTON</td> <td>1.000</td> <td>PC</td> </tr> <tr> <td>CE1270A0</td> <td>YELL/GREEN UNIP SIL RUBB WIRE D 0,75MMQ</td> <td>0.280</td> <td>M</td> </tr> <tr> <td>CE1330A0</td> <td>3 WAYS MALE INAR-LOCK CONNECTOR</td> <td>1.000</td> <td>PC</td> </tr> <tr> <td>CE1350A0</td> <td>MALE INAR-LOCK END CONNECTOR</td> <td>3.000</td> <td>PC</td> </tr> <tr> <td>CE1430A0</td> <td>BROWN UNIP. CABLE Ø1,5 MMQ</td> <td>0.350</td> <td>M</td> </tr> <tr> <td>CE1435A0</td> <td>BLUE UNIP. CABLE Ø1,5 MMQ</td> <td>0.350</td> <td>M</td> </tr> <tr> <td>CE1455A0</td> <td>TIP END FITTING</td> <td>2.000</td> <td>PC</td> </tr> <tr> <td>GN1095A0</td> <td>Ø14 - L=30 NEOPRENE SLEEVE</td> <td>2.000</td> <td>PC</td> </tr> <tr> <td>TB1505A0</td> <td>STAINLESS STEEL BENDED TUBE D13</td> <td>1.000</td> <td>PC</td> </tr> <tr> <td>V11640A0</td> <td>BRASS NUT M13x1 H7 CH1</td> <td>1.000</td> <td>PC</td> </tr> <tr> <td>V11645A0</td> <td>NICKEL BRASS NUT M13x1 H4 CH1</td> <td>1.000</td> <td>PC</td> </tr> </tbody> </table>	Code	Description	Qty	UOM	CE1155A0	6,3x0,81 - 2,5 ALPACA FEMALE FASTON	1.000	PC	CE1270A0	YELL/GREEN UNIP SIL RUBB WIRE D 0,75MMQ	0.280	M	CE1330A0	3 WAYS MALE INAR-LOCK CONNECTOR	1.000	PC	CE1350A0	MALE INAR-LOCK END CONNECTOR	3.000	PC	CE1430A0	BROWN UNIP. CABLE Ø1,5 MMQ	0.350	M	CE1435A0	BLUE UNIP. CABLE Ø1,5 MMQ	0.350	M	CE1455A0	TIP END FITTING	2.000	PC	GN1095A0	Ø14 - L=30 NEOPRENE SLEEVE	2.000	PC	TB1505A0	STAINLESS STEEL BENDED TUBE D13	1.000	PC	V11640A0	BRASS NUT M13x1 H7 CH1	1.000	PC	V11645A0	NICKEL BRASS NUT M13x1 H4 CH1	1.000	PC
Code	Description	Qty	UOM																																																		
CE1155A0	6,3x0,81 - 2,5 ALPACA FEMALE FASTON	1.000	PC																																																		
CE1270A0	YELL/GREEN UNIP SIL RUBB WIRE D 0,75MMQ	0.280	M																																																		
CE1330A0	3 WAYS MALE INAR-LOCK CONNECTOR	1.000	PC																																																		
CE1350A0	MALE INAR-LOCK END CONNECTOR	3.000	PC																																																		
CE1430A0	BROWN UNIP. CABLE Ø1,5 MMQ	0.350	M																																																		
CE1435A0	BLUE UNIP. CABLE Ø1,5 MMQ	0.350	M																																																		
CE1455A0	TIP END FITTING	2.000	PC																																																		
GN1095A0	Ø14 - L=30 NEOPRENE SLEEVE	2.000	PC																																																		
TB1505A0	STAINLESS STEEL BENDED TUBE D13	1.000	PC																																																		
V11640A0	BRASS NUT M13x1 H7 CH1	1.000	PC																																																		
V11645A0	NICKEL BRASS NUT M13x1 H4 CH1	1.000	PC																																																		





COMPONENT			SPARE PART																		
Code	Description	Image	Code	Description	Kit components																
TB1830A	TB1830A2		KTB1830A	SP010 SP020 CONT GRILL HANDLE TUBE KIT	<table border="1"> <thead> <tr> <th>Code</th> <th>Description</th> <th>Qty</th> <th>UOM</th> </tr> </thead> <tbody> <tr> <td>TB1830A2</td> <td>TB1830A2</td> <td>1.000</td> <td>PC</td> </tr> <tr> <td>V11605A0</td> <td>BUSHINGS M5 FTT-C-TC KNURLED</td> <td>1.000</td> <td>PC</td> </tr> </tbody> </table>	Code	Description	Qty	UOM	TB1830A2	TB1830A2	1.000	PC	V11605A0	BUSHINGS M5 FTT-C-TC KNURLED	1.000	PC				
Code	Description	Qty	UOM																		
TB1830A2	TB1830A2	1.000	PC																		
V11605A0	BUSHINGS M5 FTT-C-TC KNURLED	1.000	PC																		
VI1096A	M10x110 TCEI SCRE		KVI1096A	M10x110 SCREW 10 PCS. KIT	<table border="1"> <thead> <tr> <th>Code</th> <th>Description</th> <th>Qty</th> <th>UOM</th> </tr> </thead> <tbody> <tr> <td>VI1096A0</td> <td>M10x110 TCEI SCREW</td> <td>10.000</td> <td>PC</td> </tr> </tbody> </table>	Code	Description	Qty	UOM	VI1096A0	M10x110 TCEI SCREW	10.000	PC								
Code	Description	Qty	UOM																		
VI1096A0	M10x110 TCEI SCREW	10.000	PC																		
VI1655A	LID FULCRUM PIN D6.8 M5x0.8 H23		KVI1655A	LID FULCRUM PIN 4 PCS. KIT	<table border="1"> <thead> <tr> <th>Code</th> <th>Description</th> <th>Qty</th> <th>UOM</th> </tr> </thead> <tbody> <tr> <td>VI1655A0</td> <td>LID FULCRUM PIN D6.8 M5x0.8 H23</td> <td>4.000</td> <td>PC</td> </tr> </tbody> </table>	Code	Description	Qty	UOM	VI1655A0	LID FULCRUM PIN D6.8 M5x0.8 H23	4.000	PC								
Code	Description	Qty	UOM																		
VI1655A0	LID FULCRUM PIN D6.8 M5x0.8 H23	4.000	PC																		
VM1512A	SPIDO.COOK SPRING FIXING RIN		VM1512A0	SPIDO.COOK SPRING FIXING RIN																	
VT1126A	250x250 BLACK RIBBED GLASSCERAMIC		KVT1126A	SINGLE UPPER BLACK RIBBED GLASS KIT	<table border="1"> <thead> <tr> <th>Code</th> <th>Description</th> <th>Qty</th> <th>UOM</th> </tr> </thead> <tbody> <tr> <td>0D2011A1</td> <td>XP UPPER GLASS FRAME</td> <td>1.000</td> <td>PC</td> </tr> <tr> <td>SL1170A1</td> <td>S57 BLACK SILICON - 310ml CARTRIDGE</td> <td>0.010</td> <td>ML</td> </tr> <tr> <td>VT1126A0</td> <td>250x250 BLACK RIBBED GLASSCERAM IC</td> <td>1.000</td> <td>PC</td> </tr> </tbody> </table>	Code	Description	Qty	UOM	0D2011A1	XP UPPER GLASS FRAME	1.000	PC	SL1170A1	S57 BLACK SILICON - 310ml CARTRIDGE	0.010	ML	VT1126A0	250x250 BLACK RIBBED GLASSCERAM IC	1.000	PC
Code	Description	Qty	UOM																		
0D2011A1	XP UPPER GLASS FRAME	1.000	PC																		
SL1170A1	S57 BLACK SILICON - 310ml CARTRIDGE	0.010	ML																		
VT1126A0	250x250 BLACK RIBBED GLASSCERAM IC	1.000	PC																		

ASM0092C/0.D02 - General overview - FRONT

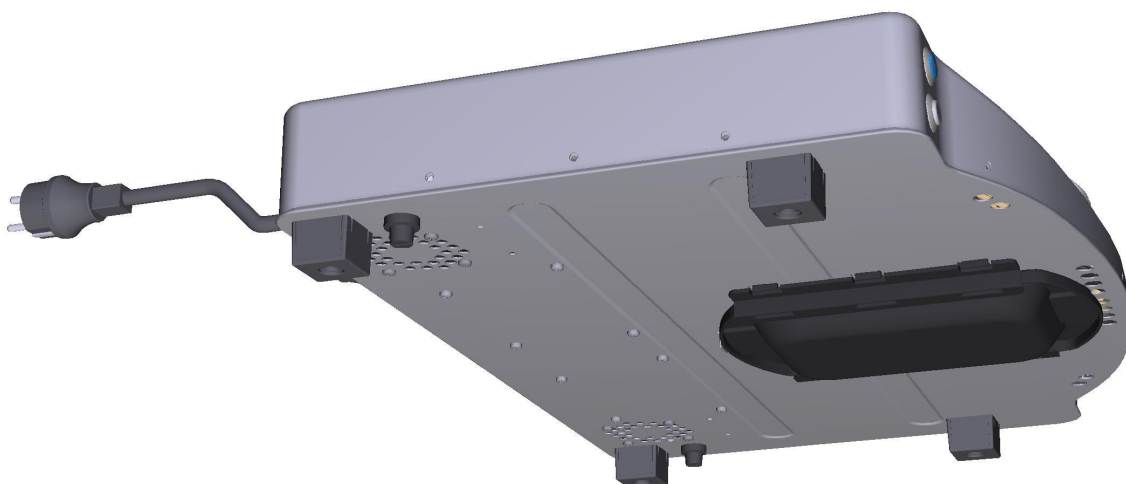





ASM0092C/0.D02 - General overview - REAR





COMPONENT			SPARE PART																										
Code	Description	Image	Code	Description	Kit components																								
VM1776A	"GOLD ""0-1"" MATT SILVER KEY"		KVE0108A	0 - 1 SWITCH BUTTON KIT	<table border="1"> <thead> <tr> <th>Code</th> <th>Description</th> <th>Qty</th> <th>UOM</th> </tr> </thead> <tbody> <tr> <td>VE1170A0</td> <td>D16 OPAQUE NICKEL ELLIPTICAL SUPPORT</td> <td>2.000</td> <td>PC</td> </tr> <tr> <td>VE1561A0</td> <td>NA/NA BIPOLAR SWITCH</td> <td>1.000</td> <td>PC</td> </tr> <tr> <td>VM1776A0</td> <td>"GOLD ""0-1"" MATT SILVER KEY"</td> <td>1.000</td> <td>PC</td> </tr> </tbody> </table>	Code	Description	Qty	UOM	VE1170A0	D16 OPAQUE NICKEL ELLIPTICAL SUPPORT	2.000	PC	VE1561A0	NA/NA BIPOLAR SWITCH	1.000	PC	VM1776A0	"GOLD ""0-1"" MATT SILVER KEY"	1.000	PC								
Code	Description	Qty	UOM																										
VE1170A0	D16 OPAQUE NICKEL ELLIPTICAL SUPPORT	2.000	PC																										
VE1561A0	NA/NA BIPOLAR SWITCH	1.000	PC																										
VM1776A0	"GOLD ""0-1"" MATT SILVER KEY"	1.000	PC																										
TR1136A	318°C -0/+24 1 POLE SAFETY THERMOSTAT		KTR1136A	318°C -0/+24 SAFETY THERMOSTAT KIT	<table border="1"> <thead> <tr> <th>Code</th> <th>Description</th> <th>Qty</th> <th>UOM</th> </tr> </thead> <tbody> <tr> <td>0H8120A0</td> <td>XEVL BULB PASS-THROU GH COVER</td> <td>1.000</td> <td>PC</td> </tr> <tr> <td>GN1531A0</td> <td>THERMOSTAT BULB INLET SEALING</td> <td>1.000</td> <td>PC</td> </tr> <tr> <td>SL1045A0</td> <td>S57 BLACK SILICONE - 80ml CARTRIDGE</td> <td>1.000</td> <td>PC</td> </tr> <tr> <td>TR1136A0</td> <td>318°C -0/+24 1 POLE SAFETY THERMOSTAT</td> <td>1.000</td> <td>PC</td> </tr> <tr> <td>VI1220A1</td> <td>4,2x12 TCB SELF-TAPPIN G SCREW</td> <td>3.000</td> <td>PC</td> </tr> </tbody> </table>	Code	Description	Qty	UOM	0H8120A0	XEVL BULB PASS-THROU GH COVER	1.000	PC	GN1531A0	THERMOSTAT BULB INLET SEALING	1.000	PC	SL1045A0	S57 BLACK SILICONE - 80ml CARTRIDGE	1.000	PC	TR1136A0	318°C -0/+24 1 POLE SAFETY THERMOSTAT	1.000	PC	VI1220A1	4,2x12 TCB SELF-TAPPIN G SCREW	3.000	PC
Code	Description	Qty	UOM																										
0H8120A0	XEVL BULB PASS-THROU GH COVER	1.000	PC																										
GN1531A0	THERMOSTAT BULB INLET SEALING	1.000	PC																										
SL1045A0	S57 BLACK SILICONE - 80ml CARTRIDGE	1.000	PC																										
TR1136A0	318°C -0/+24 1 POLE SAFETY THERMOSTAT	1.000	PC																										
VI1220A1	4,2x12 TCB SELF-TAPPIN G SCREW	3.000	PC																										
VM1750A	BRASS COMB CLAM		KVM1750A	COMB TERMINAL BLOCK KIT	<table border="1"> <thead> <tr> <th>Code</th> <th>Description</th> <th>Qty</th> <th>UOM</th> </tr> </thead> <tbody> <tr> <td>VI1040A0</td> <td>INDENTED INTERNAL WASHER D=6 ZN</td> <td>2.000</td> <td>PC</td> </tr> <tr> <td>VM1750A0</td> <td>BRASS COMB CLAMP</td> <td>1.000</td> <td>PC</td> </tr> </tbody> </table>	Code	Description	Qty	UOM	VI1040A0	INDENTED INTERNAL WASHER D=6 ZN	2.000	PC	VM1750A0	BRASS COMB CLAMP	1.000	PC												
Code	Description	Qty	UOM																										
VI1040A0	INDENTED INTERNAL WASHER D=6 ZN	2.000	PC																										
VM1750A0	BRASS COMB CLAMP	1.000	PC																										
PE1790C	SpidoCook POWER CARD		KPE1790C	POWER BOARD KIT	<table border="1"> <thead> <tr> <th>Code</th> <th>Description</th> <th>Qty</th> <th>UOM</th> </tr> </thead> <tbody> <tr> <td>CE1155A0</td> <td>6,3x0,81 - 2.5 ALPACA FEMALE FASTON</td> <td>4.000</td> <td>PC</td> </tr> <tr> <td>CE1165A0</td> <td>Cu+Sn BROWN UNIP SIL RUBB WIRE D2,5MMQ</td> <td>0.600</td> <td>M</td> </tr> <tr> <td>CE1285A0</td> <td>EMI ROUND FERRITE MOD.26438015 02</td> <td>1.000</td> <td>PC</td> </tr> </tbody> </table>	Code	Description	Qty	UOM	CE1155A0	6,3x0,81 - 2.5 ALPACA FEMALE FASTON	4.000	PC	CE1165A0	Cu+Sn BROWN UNIP SIL RUBB WIRE D2,5MMQ	0.600	M	CE1285A0	EMI ROUND FERRITE MOD.26438015 02	1.000	PC								
Code	Description	Qty	UOM																										
CE1155A0	6,3x0,81 - 2.5 ALPACA FEMALE FASTON	4.000	PC																										
CE1165A0	Cu+Sn BROWN UNIP SIL RUBB WIRE D2,5MMQ	0.600	M																										
CE1285A0	EMI ROUND FERRITE MOD.26438015 02	1.000	PC																										



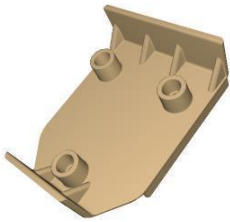

COMPONENT			SPARE PART																																															
Code	Description	Image	Code	Description	Kit components																																													
PE1790C	SpidoCook POWER CARD		KPE1790C	POWER BOARD KIT	<table border="1"> <thead> <tr> <th>Code</th> <th>Description</th> <th>Qty</th> <th>UOM</th> </tr> </thead> <tbody> <tr> <td>CE1660A0</td> <td>6,3x0,8 FEMALE FASTON COVE</td> <td>4.000</td> <td>PC</td> </tr> <tr> <td>CE1725A0</td> <td>ROBOTICS SILICON PIPE 4x0,5 MMQ</td> <td>0.600</td> <td>M</td> </tr> <tr> <td>CE1735A0</td> <td>MINIFIT FEMALE END FITTING</td> <td>8.000</td> <td>PC</td> </tr> <tr> <td>CE1755A0</td> <td>4 WAYS MALE MINIFIT CONNECTOR</td> <td>2.000</td> <td>PC</td> </tr> <tr> <td>CE1771A1</td> <td>WARNING LIGHT CONNECTION CABLE</td> <td>1.000</td> <td>PC</td> </tr> <tr> <td>PE1790C0</td> <td>SpidoCook POWER CARD</td> <td>1.000</td> <td>PC</td> </tr> <tr> <td>VM1447A0</td> <td>MM 230x450 PINK ESD AIRBALL BAG</td> <td>1.000</td> <td>PC</td> </tr> </tbody> </table>	Code	Description	Qty	UOM	CE1660A0	6,3x0,8 FEMALE FASTON COVE	4.000	PC	CE1725A0	ROBOTICS SILICON PIPE 4x0,5 MMQ	0.600	M	CE1735A0	MINIFIT FEMALE END FITTING	8.000	PC	CE1755A0	4 WAYS MALE MINIFIT CONNECTOR	2.000	PC	CE1771A1	WARNING LIGHT CONNECTION CABLE	1.000	PC	PE1790C0	SpidoCook POWER CARD	1.000	PC	VM1447A0	MM 230x450 PINK ESD AIRBALL BAG	1.000	PC													
			Code	Description	Qty	UOM																																												
CE1660A0	6,3x0,8 FEMALE FASTON COVE	4.000	PC																																															
CE1725A0	ROBOTICS SILICON PIPE 4x0,5 MMQ	0.600	M																																															
CE1735A0	MINIFIT FEMALE END FITTING	8.000	PC																																															
CE1755A0	4 WAYS MALE MINIFIT CONNECTOR	2.000	PC																																															
CE1771A1	WARNING LIGHT CONNECTION CABLE	1.000	PC																																															
PE1790C0	SpidoCook POWER CARD	1.000	PC																																															
VM1447A0	MM 230x450 PINK ESD AIRBALL BAG	1.000	PC																																															
KPE0002A	SBUX XP010ER-SB BOARDS UPGRADE KIT	<table border="1"> <thead> <tr> <th>Code</th> <th>Description</th> <th>Qty</th> <th>UOM</th> </tr> </thead> <tbody> <tr> <td>CE1285A0</td> <td>EMI ROUND FERRITE MOD.26438015 02</td> <td>1.000</td> <td>PC</td> </tr> <tr> <td>CE1725A0</td> <td>ROBOTICS SILICON PIPE 4x0,5 MMQ</td> <td>0.600</td> <td>M</td> </tr> <tr> <td>CE1735A0</td> <td>MINIFIT FEMALE END FITTING</td> <td>8.000</td> <td>PC</td> </tr> <tr> <td>CE1755A0</td> <td>4 WAYS MALE MINIFIT CONNECTOR</td> <td>2.000</td> <td>PC</td> </tr> <tr> <td>PE1645B0</td> <td>12VDC Ø42MM EXTERNAL BUZZER</td> <td>1.000</td> <td>PC</td> </tr> <tr> <td>PE1790C0</td> <td>SpidoCook POWER CARD</td> <td>1.000</td> <td>PC</td> </tr> <tr> <td>PE1986B1</td> <td>SB SPIDOCOOK CONTROL BOARD</td> <td>1.000</td> <td>PC</td> </tr> <tr> <td>VI1951A0</td> <td>ZINC PLATED BLACK CROSS SCREW 3,5x16</td> <td>3.000</td> <td>PC</td> </tr> <tr> <td>VM1447A0</td> <td>MM 230x450 PINK ESD AIRBALL BAG</td> <td>1.000</td> <td>PC</td> </tr> <tr> <td>VM1745A0</td> <td>CARD SUPPORT</td> <td>7.000</td> <td>PC</td> </tr> <tr> <td>VM2022A0</td> <td>DIGITAL XP WIRING COVE</td> <td>1.000</td> <td>PC</td> </tr> </tbody> </table>	Code	Description	Qty	UOM	CE1285A0	EMI ROUND FERRITE MOD.26438015 02	1.000	PC	CE1725A0	ROBOTICS SILICON PIPE 4x0,5 MMQ	0.600	M	CE1735A0	MINIFIT FEMALE END FITTING	8.000	PC	CE1755A0	4 WAYS MALE MINIFIT CONNECTOR	2.000	PC	PE1645B0	12VDC Ø42MM EXTERNAL BUZZER	1.000	PC	PE1790C0	SpidoCook POWER CARD	1.000	PC	PE1986B1	SB SPIDOCOOK CONTROL BOARD	1.000	PC	VI1951A0	ZINC PLATED BLACK CROSS SCREW 3,5x16	3.000	PC	VM1447A0	MM 230x450 PINK ESD AIRBALL BAG	1.000	PC	VM1745A0	CARD SUPPORT	7.000	PC	VM2022A0	DIGITAL XP WIRING COVE	1.000	PC
Code	Description	Qty	UOM																																															
CE1285A0	EMI ROUND FERRITE MOD.26438015 02	1.000	PC																																															
CE1725A0	ROBOTICS SILICON PIPE 4x0,5 MMQ	0.600	M																																															
CE1735A0	MINIFIT FEMALE END FITTING	8.000	PC																																															
CE1755A0	4 WAYS MALE MINIFIT CONNECTOR	2.000	PC																																															
PE1645B0	12VDC Ø42MM EXTERNAL BUZZER	1.000	PC																																															
PE1790C0	SpidoCook POWER CARD	1.000	PC																																															
PE1986B1	SB SPIDOCOOK CONTROL BOARD	1.000	PC																																															
VI1951A0	ZINC PLATED BLACK CROSS SCREW 3,5x16	3.000	PC																																															
VM1447A0	MM 230x450 PINK ESD AIRBALL BAG	1.000	PC																																															
VM1745A0	CARD SUPPORT	7.000	PC																																															
VM2022A0	DIGITAL XP WIRING COVE	1.000	PC																																															

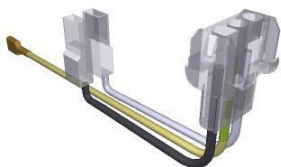
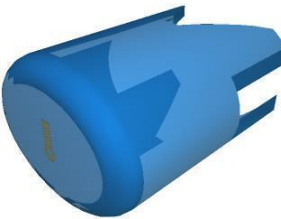
COMPONENT			SPARE PART																						
Code	Description	Image	Code	Description	Kit components																				
SN1025A	SN1025A0		KSN1025A	PT100 500°C TEMPERATURE PROBE KIT	<table border="1"> <thead> <tr> <th>Code</th> <th>Description</th> <th>Qty</th> <th>UOM</th> </tr> </thead> <tbody> <tr> <td>SN1025A0</td> <td>SN1025A0</td> <td>1.000</td> <td>PC</td> </tr> </tbody> </table>	Code	Description	Qty	UOM	SN1025A0	SN1025A0	1.000	PC												
Code	Description	Qty	UOM																						
SN1025A0	SN1025A0	1.000	PC																						
VM1745A	CARD SUPPORT		KVM1745A	BOARD SUPPORT 10 PCS KIT	<table border="1"> <thead> <tr> <th>Code</th> <th>Description</th> <th>Qty</th> <th>UOM</th> </tr> </thead> <tbody> <tr> <td>VM1745A0</td> <td>CARD SUPPORT</td> <td>10.000</td> <td>PC</td> </tr> </tbody> </table>	Code	Description	Qty	UOM	VM1745A0	CARD SUPPORT	10.000	PC												
Code	Description	Qty	UOM																						
VM1745A0	CARD SUPPORT	10.000	PC																						
VN1141A	COOLING DOWN FAN 12V 60x60x26		KVN1141A	DIGITAL CLAMPSHELL GRILL CONTROL FAN KIT	<table border="1"> <thead> <tr> <th>Code</th> <th>Description</th> <th>Qty</th> <th>UOM</th> </tr> </thead> <tbody> <tr> <td>V11865A0</td> <td>5X10 TCB+ SELF-THREADI NG SCREW</td> <td>4.000</td> <td>PC</td> </tr> <tr> <td>VN1141A1</td> <td>COOLING DOWN FAN 12V 60x60x26</td> <td>1.000</td> <td>PC</td> </tr> </tbody> </table>	Code	Description	Qty	UOM	V11865A0	5X10 TCB+ SELF-THREADI NG SCREW	4.000	PC	VN1141A1	COOLING DOWN FAN 12V 60x60x26	1.000	PC								
Code	Description	Qty	UOM																						
V11865A0	5X10 TCB+ SELF-THREADI NG SCREW	4.000	PC																						
VN1141A1	COOLING DOWN FAN 12V 60x60x26	1.000	PC																						
GN1507A	O-RING 2225		GN1507A0	O-RING 2225																					
PE2150A	4P 350°C SPIDOGLOSS COMPLETE CONTROL		KPE2150A	350°C SPIDOGLOSS CONTROL BOARD KIT 4PROG	<table border="1"> <thead> <tr> <th>Code</th> <th>Description</th> <th>Qty</th> <th>UOM</th> </tr> </thead> <tbody> <tr> <td>PE2150A0</td> <td>4P 350°C SPIDOGLOSS COMPLETE CONTROL</td> <td>1.000</td> <td>PC</td> </tr> <tr> <td>V11951A0</td> <td>ZINC PLATED BLACK CROSS SCREW 3,5x16</td> <td>3.000</td> <td>PC</td> </tr> <tr> <td>VM1447A0</td> <td>MM 230x450 PINK ESD AIRBALL BAG</td> <td>0.500</td> <td>PC</td> </tr> <tr> <td>VM2022A0</td> <td>DIGITAL XP WIRING COVE</td> <td>1.000</td> <td>PC</td> </tr> </tbody> </table>	Code	Description	Qty	UOM	PE2150A0	4P 350°C SPIDOGLOSS COMPLETE CONTROL	1.000	PC	V11951A0	ZINC PLATED BLACK CROSS SCREW 3,5x16	3.000	PC	VM1447A0	MM 230x450 PINK ESD AIRBALL BAG	0.500	PC	VM2022A0	DIGITAL XP WIRING COVE	1.000	PC
Code	Description	Qty	UOM																						
PE2150A0	4P 350°C SPIDOGLOSS COMPLETE CONTROL	1.000	PC																						
V11951A0	ZINC PLATED BLACK CROSS SCREW 3,5x16	3.000	PC																						
VM1447A0	MM 230x450 PINK ESD AIRBALL BAG	0.500	PC																						
VM2022A0	DIGITAL XP WIRING COVE	1.000	PC																						

COMPONENT			SPARE PART																																															
Code	Description	Image	Code	Description	Kit components																																													
VM2022A	DIGITAL XP WIRING COVER		KPE2028A	SPIDOCOOK 4 PROGRAMS CONTROL BOARD KIT	<table border="1"> <thead> <tr> <th>Code</th> <th>Description</th> <th>Qty</th> <th>UOM</th> </tr> </thead> <tbody> <tr> <td>PE2028A0</td> <td>SpidoCook 4 PROGRAMS CONTROL BOARD</td> <td>1.000</td> <td>PC</td> </tr> <tr> <td>V11951A0</td> <td>ZINC PLATED BLACK CROSS SCREW 3,5x16</td> <td>3.000</td> <td>PC</td> </tr> <tr> <td>VM2022A0</td> <td>DIGITAL XP WIRING COVE</td> <td>1.000</td> <td>PC</td> </tr> </tbody> </table>	Code	Description	Qty	UOM	PE2028A0	SpidoCook 4 PROGRAMS CONTROL BOARD	1.000	PC	V11951A0	ZINC PLATED BLACK CROSS SCREW 3,5x16	3.000	PC	VM2022A0	DIGITAL XP WIRING COVE	1.000	PC																													
			Code	Description	Qty	UOM																																												
			PE2028A0	SpidoCook 4 PROGRAMS CONTROL BOARD	1.000	PC																																												
V11951A0	ZINC PLATED BLACK CROSS SCREW 3,5x16	3.000	PC																																															
VM2022A0	DIGITAL XP WIRING COVE	1.000	PC																																															
KPE0002A	SBUX XP010ER-SB BOARDS UPGRADE KIT	<table border="1"> <thead> <tr> <th>Code</th> <th>Description</th> <th>Qty</th> <th>UOM</th> </tr> </thead> <tbody> <tr> <td>CE1285A0</td> <td>EMI ROUND FERRITE MOD.26438015 02</td> <td>1.000</td> <td>PC</td> </tr> <tr> <td>CE1725A0</td> <td>ROBOTICS SILICON PIPE 4x0,5 MMQ</td> <td>0.600</td> <td>M</td> </tr> <tr> <td>CE1735A0</td> <td>MINIFIT FEMALE END FITTING</td> <td>8.000</td> <td>PC</td> </tr> <tr> <td>CE1755A0</td> <td>4 WAYS MALE MINIFIT CONNECTOR</td> <td>2.000</td> <td>PC</td> </tr> <tr> <td>PE1645B0</td> <td>12VDC Ø42MM EXTERNAL BUZZER</td> <td>1.000</td> <td>PC</td> </tr> <tr> <td>PE1790C0</td> <td>SpidoCook POWER CARD</td> <td>1.000</td> <td>PC</td> </tr> <tr> <td>PE1986B1</td> <td>SB SPIDOCOOK CONTROL BOARD</td> <td>1.000</td> <td>PC</td> </tr> <tr> <td>V11951A0</td> <td>ZINC PLATED BLACK CROSS SCREW 3,5x16</td> <td>3.000</td> <td>PC</td> </tr> <tr> <td>VM1447A0</td> <td>MM 230x450 PINK ESD AIRBALL BAG</td> <td>1.000</td> <td>PC</td> </tr> <tr> <td>VM1745A0</td> <td>CARD SUPPORT</td> <td>7.000</td> <td>PC</td> </tr> <tr> <td>VM2022A0</td> <td>DIGITAL XP WIRING COVE</td> <td>1.000</td> <td>PC</td> </tr> </tbody> </table>	Code	Description	Qty	UOM	CE1285A0	EMI ROUND FERRITE MOD.26438015 02	1.000	PC	CE1725A0	ROBOTICS SILICON PIPE 4x0,5 MMQ	0.600	M	CE1735A0	MINIFIT FEMALE END FITTING	8.000	PC	CE1755A0	4 WAYS MALE MINIFIT CONNECTOR	2.000	PC	PE1645B0	12VDC Ø42MM EXTERNAL BUZZER	1.000	PC	PE1790C0	SpidoCook POWER CARD	1.000	PC	PE1986B1	SB SPIDOCOOK CONTROL BOARD	1.000	PC	V11951A0	ZINC PLATED BLACK CROSS SCREW 3,5x16	3.000	PC	VM1447A0	MM 230x450 PINK ESD AIRBALL BAG	1.000	PC	VM1745A0	CARD SUPPORT	7.000	PC	VM2022A0	DIGITAL XP WIRING COVE	1.000	PC
Code	Description	Qty	UOM																																															
CE1285A0	EMI ROUND FERRITE MOD.26438015 02	1.000	PC																																															
CE1725A0	ROBOTICS SILICON PIPE 4x0,5 MMQ	0.600	M																																															
CE1735A0	MINIFIT FEMALE END FITTING	8.000	PC																																															
CE1755A0	4 WAYS MALE MINIFIT CONNECTOR	2.000	PC																																															
PE1645B0	12VDC Ø42MM EXTERNAL BUZZER	1.000	PC																																															
PE1790C0	SpidoCook POWER CARD	1.000	PC																																															
PE1986B1	SB SPIDOCOOK CONTROL BOARD	1.000	PC																																															
V11951A0	ZINC PLATED BLACK CROSS SCREW 3,5x16	3.000	PC																																															
VM1447A0	MM 230x450 PINK ESD AIRBALL BAG	1.000	PC																																															
VM1745A0	CARD SUPPORT	7.000	PC																																															
VM2022A0	DIGITAL XP WIRING COVE	1.000	PC																																															
KPE0001A	SPIDOCOOK DIGITAL CARDS REPLACEMENT KIT	<table border="1"> <thead> <tr> <th>Code</th> <th>Description</th> <th>Qty</th> <th>UOM</th> </tr> </thead> <tbody> <tr> <td>CE1285A0</td> <td>EMI ROUND FERRITE MOD.26438015 02</td> <td>1.000</td> <td>PC</td> </tr> <tr> <td>CE1725A0</td> <td>ROBOTICS SILICON PIPE 4x0,5 MMQ</td> <td>0.600</td> <td>M</td> </tr> <tr> <td>CE1735A0</td> <td>MINIFIT FEMALE END FITTING</td> <td>8.000</td> <td>PC</td> </tr> </tbody> </table>	Code	Description	Qty	UOM	CE1285A0	EMI ROUND FERRITE MOD.26438015 02	1.000	PC	CE1725A0	ROBOTICS SILICON PIPE 4x0,5 MMQ	0.600	M	CE1735A0	MINIFIT FEMALE END FITTING	8.000	PC																																
Code	Description	Qty	UOM																																															
CE1285A0	EMI ROUND FERRITE MOD.26438015 02	1.000	PC																																															
CE1725A0	ROBOTICS SILICON PIPE 4x0,5 MMQ	0.600	M																																															
CE1735A0	MINIFIT FEMALE END FITTING	8.000	PC																																															

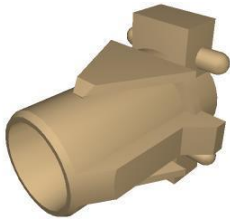
COMPONENT			SPARE PART																														
Code	Description	Image	Code	Description	Kit components																												
VM2022A	DIGITAL XP WIRING COVER		KPE0001A	SPIDOCOOK DIGITAL CARDS REPLACEMENT KIT	<table border="1"> <thead> <tr> <th>Code</th> <th>Description</th> <th>Qty</th> <th>UOM</th> </tr> </thead> <tbody> <tr> <td>CE1755A0</td> <td>4 WAYS MALE MINIFIT CONNECTOR</td> <td>2.000</td> <td>PC</td> </tr> <tr> <td>PE1790B0</td> <td>SPIDOCOOK POWER CARD</td> <td>1.000</td> <td>PC</td> </tr> <tr> <td>PE2028A0</td> <td>SpidoCook 4 PROGRAMS CONTROL BOARD</td> <td>1.000</td> <td>PC</td> </tr> <tr> <td>VI1951A0</td> <td>ZINC PLATED BLACK CROSS SCREW 3,5x16</td> <td>3.000</td> <td>PC</td> </tr> <tr> <td>VM1745A0</td> <td>CARD SUPPORT</td> <td>7.000</td> <td>PC</td> </tr> <tr> <td>VM2022A0</td> <td>DIGITAL XP WIRING COVE</td> <td>1.000</td> <td>PC</td> </tr> </tbody> </table>	Code	Description	Qty	UOM	CE1755A0	4 WAYS MALE MINIFIT CONNECTOR	2.000	PC	PE1790B0	SPIDOCOOK POWER CARD	1.000	PC	PE2028A0	SpidoCook 4 PROGRAMS CONTROL BOARD	1.000	PC	VI1951A0	ZINC PLATED BLACK CROSS SCREW 3,5x16	3.000	PC	VM1745A0	CARD SUPPORT	7.000	PC	VM2022A0	DIGITAL XP WIRING COVE	1.000	PC
Code	Description	Qty	UOM																														
CE1755A0	4 WAYS MALE MINIFIT CONNECTOR	2.000	PC																														
PE1790B0	SPIDOCOOK POWER CARD	1.000	PC																														
PE2028A0	SpidoCook 4 PROGRAMS CONTROL BOARD	1.000	PC																														
VI1951A0	ZINC PLATED BLACK CROSS SCREW 3,5x16	3.000	PC																														
VM1745A0	CARD SUPPORT	7.000	PC																														
VM2022A0	DIGITAL XP WIRING COVE	1.000	PC																														
RS1258A	750W 230V GLASS CERAMIC HEATING ELEMENT		KRS1258A	750W 230V GLASS CER.HEATING EL.KI	<table border="1"> <thead> <tr> <th>Code</th> <th>Description</th> <th>Qty</th> <th>UOM</th> </tr> </thead> <tbody> <tr> <td>RS1258A0</td> <td>750W 230V GLASS CERAMIC HEATING ELEMENT</td> <td>1.000</td> <td>PC</td> </tr> <tr> <td>RS1259A0</td> <td>XP BULB HOLDER PLATE L224 7.5x0.4</td> <td>1.000</td> <td>PC</td> </tr> </tbody> </table>	Code	Description	Qty	UOM	RS1258A0	750W 230V GLASS CERAMIC HEATING ELEMENT	1.000	PC	RS1259A0	XP BULB HOLDER PLATE L224 7.5x0.4	1.000	PC																
					Code	Description	Qty	UOM																									
RS1258A0	750W 230V GLASS CERAMIC HEATING ELEMENT	1.000	PC																														
RS1259A0	XP BULB HOLDER PLATE L224 7.5x0.4	1.000	PC																														
RS1259A	XP BULB HOLDER PLATE L224 7.5x0.4		KRS1258A	750W 230V GLASS CER.HEATING EL.KI	<table border="1"> <thead> <tr> <th>Code</th> <th>Description</th> <th>Qty</th> <th>UOM</th> </tr> </thead> <tbody> <tr> <td>RS1258A0</td> <td>750W 230V GLASS CERAMIC HEATING ELEMENT</td> <td>1.000</td> <td>PC</td> </tr> <tr> <td>RS1259A0</td> <td>XP BULB HOLDER PLATE L224 7.5x0.4</td> <td>1.000</td> <td>PC</td> </tr> </tbody> </table>	Code	Description	Qty	UOM	RS1258A0	750W 230V GLASS CERAMIC HEATING ELEMENT	1.000	PC	RS1259A0	XP BULB HOLDER PLATE L224 7.5x0.4	1.000	PC																
					Code	Description	Qty	UOM																									
			RS1258A0	750W 230V GLASS CERAMIC HEATING ELEMENT	1.000	PC																											
RS1259A0	XP BULB HOLDER PLATE L224 7.5x0.4	1.000	PC																														
KRS1235A	500W 230V GLASS CER. HEATING EL.KI	<table border="1"> <thead> <tr> <th>Code</th> <th>Description</th> <th>Qty</th> <th>UOM</th> </tr> </thead> <tbody> <tr> <td>RS1235A1</td> <td>500W 230V GLASS CERAMIC HEATING ELEMENT</td> <td>1.000</td> <td>PC</td> </tr> <tr> <td>RS1259A0</td> <td>XP BULB HOLDER PLATE L224 7.5x0.4</td> <td>1.000</td> <td>PC</td> </tr> </tbody> </table>	Code	Description	Qty	UOM	RS1235A1	500W 230V GLASS CERAMIC HEATING ELEMENT	1.000	PC	RS1259A0	XP BULB HOLDER PLATE L224 7.5x0.4	1.000	PC																			
Code	Description	Qty	UOM																														
RS1235A1	500W 230V GLASS CERAMIC HEATING ELEMENT	1.000	PC																														
RS1259A0	XP BULB HOLDER PLATE L224 7.5x0.4	1.000	PC																														

COMPONENT			SPARE PART																														
Code	Description	Image	Code	Description	Kit components																												
IE2305A	3 WAYS GREY INAR LOCK ADAPTER 500FC 0,75		KIE2305A	AWG 500FC 3WAYS FEM INAR-LOCK ADAPT KIT	<table border="1"> <thead> <tr> <th>Code</th> <th>Description</th> <th>Qty</th> <th>UOM</th> </tr> </thead> <tbody> <tr> <td>CE1155A0</td> <td>6,3x0,81 - 2,5 ALPACA FEMALE FASTON</td> <td>3.000</td> <td>PC</td> </tr> <tr> <td>CE1205A0</td> <td>FEMALE INAR-LOCK END CONNECTOR</td> <td>3.000</td> <td>PC</td> </tr> <tr> <td>CE1270A0</td> <td>YELL/GREEN UNIP SIL RUBB WIRE D 0,75MMQ</td> <td>0.250</td> <td>M</td> </tr> <tr> <td>CE1320A0</td> <td>GREY UNIP SIL RUBB WIRE D 0,75MMQ</td> <td>0.500</td> <td>M</td> </tr> <tr> <td>CE1485A0</td> <td>3 WAYS FEMALE INAR-LOCK CONNECTOR</td> <td>1.000</td> <td>PC</td> </tr> <tr> <td>CE1660A0</td> <td>6,3x0,8 FEMALE FASTON COVE</td> <td>2.000</td> <td>PC</td> </tr> </tbody> </table>	Code	Description	Qty	UOM	CE1155A0	6,3x0,81 - 2,5 ALPACA FEMALE FASTON	3.000	PC	CE1205A0	FEMALE INAR-LOCK END CONNECTOR	3.000	PC	CE1270A0	YELL/GREEN UNIP SIL RUBB WIRE D 0,75MMQ	0.250	M	CE1320A0	GREY UNIP SIL RUBB WIRE D 0,75MMQ	0.500	M	CE1485A0	3 WAYS FEMALE INAR-LOCK CONNECTOR	1.000	PC	CE1660A0	6,3x0,8 FEMALE FASTON COVE	2.000	PC
Code	Description	Qty	UOM																														
CE1155A0	6,3x0,81 - 2,5 ALPACA FEMALE FASTON	3.000	PC																														
CE1205A0	FEMALE INAR-LOCK END CONNECTOR	3.000	PC																														
CE1270A0	YELL/GREEN UNIP SIL RUBB WIRE D 0,75MMQ	0.250	M																														
CE1320A0	GREY UNIP SIL RUBB WIRE D 0,75MMQ	0.500	M																														
CE1485A0	3 WAYS FEMALE INAR-LOCK CONNECTOR	1.000	PC																														
CE1660A0	6,3x0,8 FEMALE FASTON COVE	2.000	PC																														
VE1530A	GOLD THERMOMETER BLUE LIGHT COVER		KLP1012A	GOLDEN THERMOMETER BLUE LIGHT KIT	<table border="1"> <thead> <tr> <th>Code</th> <th>Description</th> <th>Qty</th> <th>UOM</th> </tr> </thead> <tbody> <tr> <td>VE1170A0</td> <td>D16 OPAQUE NICKEL ELLIPTICAL SUPPORT</td> <td>1.000</td> <td>PC</td> </tr> <tr> <td>VE1530A0</td> <td>GOLD THERMOMETE R BLUE LIGHT COVER</td> <td>1.000</td> <td>PC</td> </tr> <tr> <td>VE1535A1</td> <td>230V WHITE LED</td> <td>1.000</td> <td>PC</td> </tr> <tr> <td>VM1762A0</td> <td>INNER LAMP SUPPORT</td> <td>1.000</td> <td>PC</td> </tr> <tr> <td>VM2009A0</td> <td>D16 SILVER ELLIPTICAL SUPPORT</td> <td>1.000</td> <td>PC</td> </tr> </tbody> </table>	Code	Description	Qty	UOM	VE1170A0	D16 OPAQUE NICKEL ELLIPTICAL SUPPORT	1.000	PC	VE1530A0	GOLD THERMOMETE R BLUE LIGHT COVER	1.000	PC	VE1535A1	230V WHITE LED	1.000	PC	VM1762A0	INNER LAMP SUPPORT	1.000	PC	VM2009A0	D16 SILVER ELLIPTICAL SUPPORT	1.000	PC				
Code	Description	Qty	UOM																														
VE1170A0	D16 OPAQUE NICKEL ELLIPTICAL SUPPORT	1.000	PC																														
VE1530A0	GOLD THERMOMETE R BLUE LIGHT COVER	1.000	PC																														
VE1535A1	230V WHITE LED	1.000	PC																														
VM1762A0	INNER LAMP SUPPORT	1.000	PC																														
VM2009A0	D16 SILVER ELLIPTICAL SUPPORT	1.000	PC																														
VE1545A	12V WHITE LED LIGHT		KVE1545A	12V WHITE LED 10 PCS. KIT	<table border="1"> <thead> <tr> <th>Code</th> <th>Description</th> <th>Qty</th> <th>UOM</th> </tr> </thead> <tbody> <tr> <td>VE1545A0</td> <td>12V WHITE LED LIGHT</td> <td>10.000</td> <td>PC</td> </tr> </tbody> </table>	Code	Description	Qty	UOM	VE1545A0	12V WHITE LED LIGHT	10.000	PC																				
Code	Description	Qty	UOM																														
VE1545A0	12V WHITE LED LIGHT	10.000	PC																														

COMPONENT			SPARE PART										
Code	Description	Image	Code	Description	Kit components								
VM1762A	INNER LAMP SUPPORT		KVM1762A	LAMP INTERNAL SUPPORT KIT	<table border="1"> <thead> <tr> <th>Code</th> <th>Description</th> <th>Qty</th> <th>UOM</th> </tr> </thead> <tbody> <tr> <td>VM1762A0</td> <td>INNER LAMP SUPPORT</td> <td>1.000</td> <td>PC</td> </tr> </tbody> </table>	Code	Description	Qty	UOM	VM1762A0	INNER LAMP SUPPORT	1.000	PC
Code	Description	Qty	UOM										
VM1762A0	INNER LAMP SUPPORT	1.000	PC										
MR1000A	CABLE 3x1,5 H07RN-F MT1,5+K2/3+SCHUK		KMR1000A	KIT CABLE 3X1,5 H07RN-F +K2/3+SCHUKO	<table border="1"> <thead> <tr> <th>Code</th> <th>Description</th> <th>Qty</th> <th>UOM</th> </tr> </thead> <tbody> <tr> <td>MR1000A0</td> <td>CABLE 3x1,5 H07RN-F MT1,5+K2/3+S CHUKO</td> <td>1.000</td> <td>PC</td> </tr> </tbody> </table>	Code	Description	Qty	UOM	MR1000A0	CABLE 3x1,5 H07RN-F MT1,5+K2/3+S CHUKO	1.000	PC
Code	Description	Qty	UOM										
MR1000A0	CABLE 3x1,5 H07RN-F MT1,5+K2/3+S CHUKO	1.000	PC										
PD1001A	35x35 H26 GREY PLASTIC+RUBBER FOOT		KPD1001A	35x35 H26 FEET 4 PCS KIT	<table border="1"> <thead> <tr> <th>Code</th> <th>Description</th> <th>Qty</th> <th>UOM</th> </tr> </thead> <tbody> <tr> <td>PD1001A0</td> <td>35x35 H26 GREY PLASTIC+RUB BER FOOT</td> <td>4.000</td> <td>PC</td> </tr> </tbody> </table>	Code	Description	Qty	UOM	PD1001A0	35x35 H26 GREY PLASTIC+RUB BER FOOT	4.000	PC
Code	Description	Qty	UOM										
PD1001A0	35x35 H26 GREY PLASTIC+RUB BER FOOT	4.000	PC										
VM1315A	XP FAT DRAIN		KVM1315A	XP FAT DRAIN KIT VM1315A	<table border="1"> <thead> <tr> <th>Code</th> <th>Description</th> <th>Qty</th> <th>UOM</th> </tr> </thead> <tbody> <tr> <td>VM1315A0</td> <td>XP FAT DRAIN</td> <td>1.000</td> <td>PC</td> </tr> </tbody> </table>	Code	Description	Qty	UOM	VM1315A0	XP FAT DRAIN	1.000	PC
Code	Description	Qty	UOM										
VM1315A0	XP FAT DRAIN	1.000	PC										
VM1545A	CONTACT GRILL DRIP TRAY		KVM1545A	DRIP TRAY FOR XP CONTACT GRILL KIT	<table border="1"> <thead> <tr> <th>Code</th> <th>Description</th> <th>Qty</th> <th>UOM</th> </tr> </thead> <tbody> <tr> <td>VM1545A1</td> <td>CONTACT GRILL DRIP TRAY</td> <td>1.000</td> <td>PC</td> </tr> </tbody> </table>	Code	Description	Qty	UOM	VM1545A1	CONTACT GRILL DRIP TRAY	1.000	PC
Code	Description	Qty	UOM										
VM1545A1	CONTACT GRILL DRIP TRAY	1.000	PC										

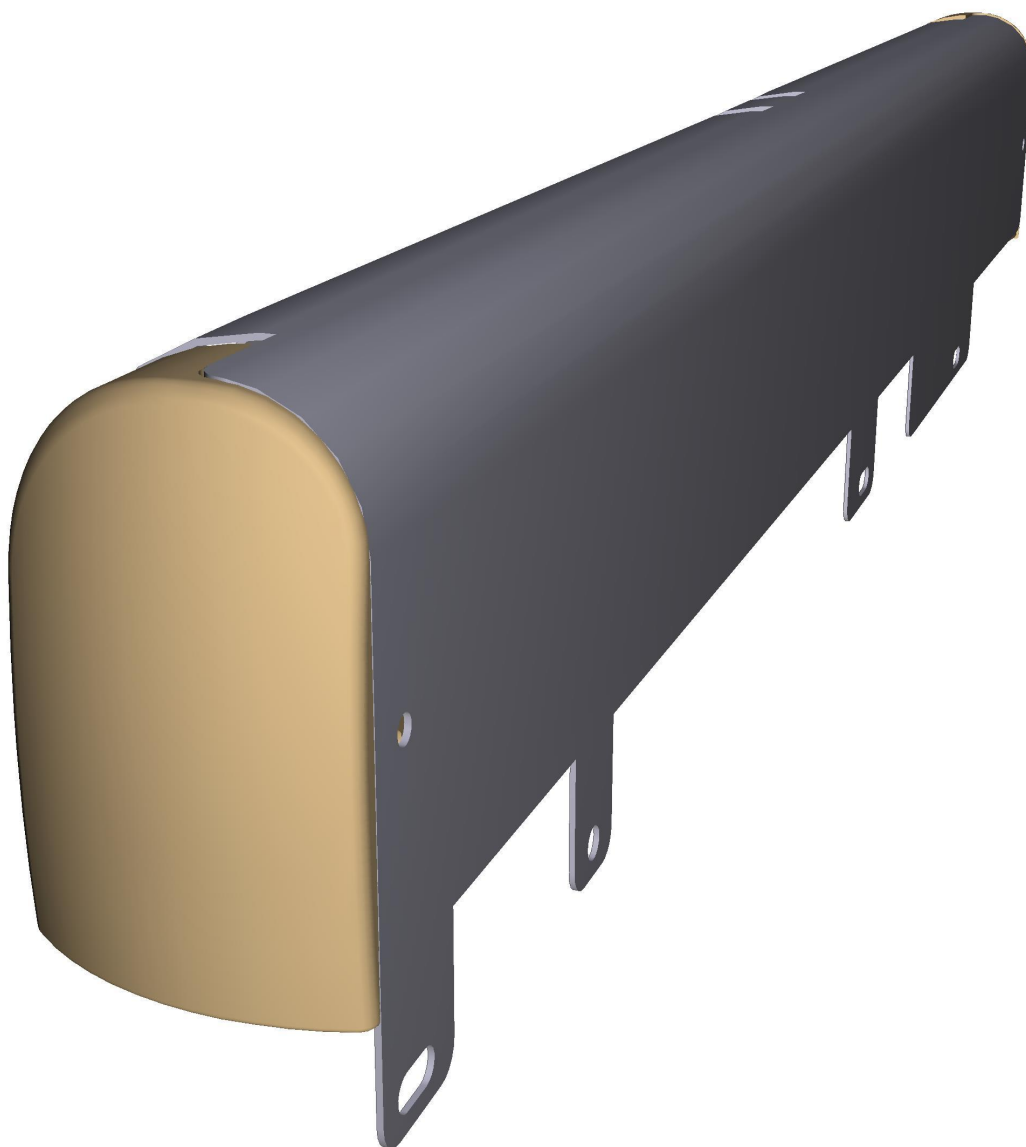

COMPONENT			SPARE PART										
<i>Code</i>	<i>Description</i>	<i>Image</i>	<i>Code</i>	<i>Description</i>	<i>Kit components</i>								
VM1546A	CONTACT GRILL DRIP TRAY GUIDE		KVM1546A	DIP TRAY GUIDE KIT	<table border="1"> <thead> <tr> <th><i>Code</i></th> <th><i>Description</i></th> <th><i>Qty</i></th> <th><i>UOM</i></th> </tr> </thead> <tbody> <tr> <td>VM1546A0</td> <td>CONTACT GRILL DRIP TRAY GUIDE</td> <td>1.000</td> <td>PC</td> </tr> </tbody> </table>	<i>Code</i>	<i>Description</i>	<i>Qty</i>	<i>UOM</i>	VM1546A0	CONTACT GRILL DRIP TRAY GUIDE	1.000	PC
<i>Code</i>	<i>Description</i>	<i>Qty</i>	<i>UOM</i>										
VM1546A0	CONTACT GRILL DRIP TRAY GUIDE	1.000	PC										

ASM0096A/0.D00 - General overview - FRONT

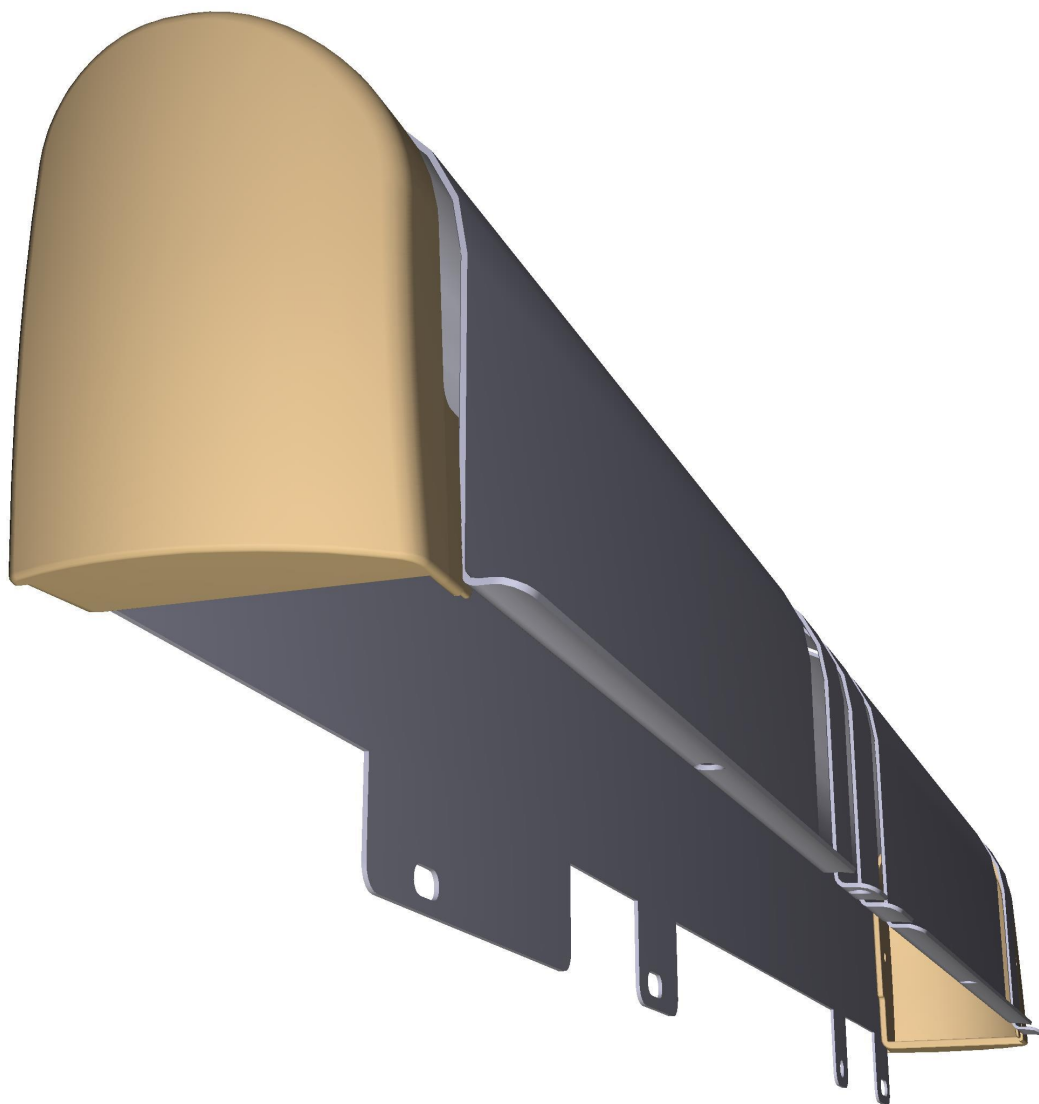

ASM0096A/0.D00 - General overview - REAR

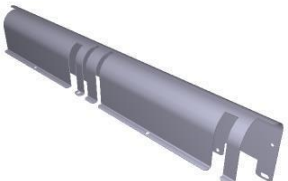

COMPONENT			SPARE PART										
Code	Description	Image	Code	Description	Kit components								
0D1990A	DOUBLE CASE MECHANISM COVER XP		0D1990A0	DOUBLE CASE MECHANISM COVER XP									
VM1550A	SP GRILL MECHANISM COVER RIGHT CAP		KVM1550A	CONT GRILL MECHANISM COVER RIGHT CAP KIT	<table border="1"> <thead> <tr> <th>Code</th> <th>Description</th> <th>Qty</th> <th>UOM</th> </tr> </thead> <tbody> <tr> <td>VM1550A1</td> <td>SP GRILL MECHANISM COVER RIGHT CAP</td> <td>1.000</td> <td>PC</td> </tr> </tbody> </table>	Code	Description	Qty	UOM	VM1550A1	SP GRILL MECHANISM COVER RIGHT CAP	1.000	PC
Code	Description	Qty	UOM										
VM1550A1	SP GRILL MECHANISM COVER RIGHT CAP	1.000	PC										
VM1551A	CONTACT GRILL LEFT MECHANISM COVER CAP		KVM1551A	SP GRILL MECHAN.COVER LEFT CAP KIT	<table border="1"> <thead> <tr> <th>Code</th> <th>Description</th> <th>Qty</th> <th>UOM</th> </tr> </thead> <tbody> <tr> <td>VM1551A1</td> <td>CONTACT GRILL LEFT MECHANISM COVER CAP</td> <td>1.000</td> <td>PC</td> </tr> </tbody> </table>	Code	Description	Qty	UOM	VM1551A1	CONTACT GRILL LEFT MECHANISM COVER CAP	1.000	PC
Code	Description	Qty	UOM										
VM1551A1	CONTACT GRILL LEFT MECHANISM COVER CAP	1.000	PC										